

WI-SA CONTROL UNIT USER MENU

VERSION
2.4

Electronic regulation unit

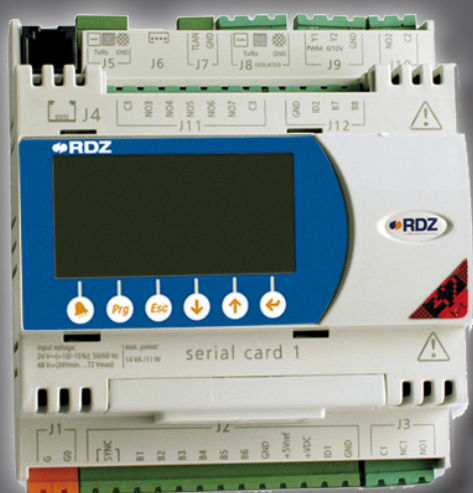

TECHNICAL MANUAL



SAFETY WARNINGS

SAFETY WARNINGS

Carefully read this booklet before starting and/or using the appliance and keep it in an easily accessible place .

Contact the manufacturer's technical office at the numbers indicated at the back of this booklet for consultancy or special technical requests.

-  **WARNING**
Installation and maintenance must be carried out only by qualified personnel or else the guarantee will be void.
- Use only original spare parts: Failure to comply with this instruction will make the guarantee void

DISPOSAL



According to the provisions of the following European directives 2011/65/EU, 2012/19/EU, and 2003/108/CE, concerning the restriction of the use of certain hazardous substances in electrical and electronic equipment, as well as waste disposal.

The crossed out wheeie bins symbol on the equipment indicates that, at the end of its useful life, the product must be collected separately from general waste. Therefore, at the end of its useful life, the user must take the equipment to a designated electrical and electronic waste collection point , or return it to the dealer that, against the purchase of an equivalent appliance, it is obliged to collect the product for disposal free of charge. Appropriate differentiated waste collection for subsequent recycling, treatment and environment-friendly disposal of the discarded equipment helps preventing possible negative environmental and health effects and encourages recycling of the component materials of the equipment. Illegal disposal of the product by the user entails the application of sanctions provided by the regulations in force.



CONTENTS

Description	Page
Presentation	4
General description	5
Summary overview of the screenshot	6
Functional overview of the screenshot	8
Actions on the menus	15
ε - INFO Menu screenshot	16
0 - Main screenshot	16
1 - general On-Off screenshot (in the event of multi-systems)	18
2 - System/Zone Menu Screenshot	19
3 - Settings Menu Screenshot	40
Troubleshooting	49



PRESENTATION

WI control unit is customisable and can be used to manage up to 8 mixing systems, 64 climate zones with 64 independent dehumidifiers and control up to 8 air handling units (AHU) with the dehumidification, ventilation, air renewal and integration functions.

Moreover, it can be used in the following operating modes:

- **AUTONOMOUS MODE:** to be installed on systems with independent power production.
- **SLAVE MODE:** to be installed on systems with centralised power production. This configuration provides for the use of WI.MASTER.NET control unit.

The illustrated user manual describes all the possible operating modes.

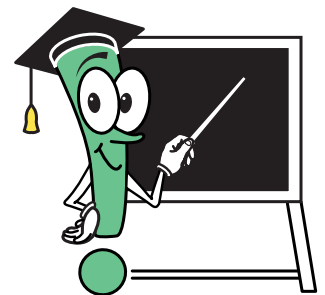

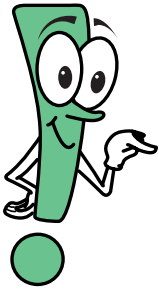

The control unit is structured in two "access levels":

- **“basic”**: the user can enter the desired temperature values, daily and weekly operating time slots, etc. The data entered are essential for the control unit to meet the user's requirements.
- **“advanced”**: password-protected, where all the machine settings are configured. These can be accessed only by specialised technicians, since incorrect value entries generate malfunctions. The settings configured by the specialised technician (using the dedicated menu) will allow displaying only the necessary screenshot in the user menu, hiding the other ones for clarity and ease of use.

The control unit is quick and easy to use, since the user is guided through the reading and data entering processes by clear flashing symbols that help selecting which buttons to use (refer to **Table A** - Flashing symbols).

The procedure to enter data is the same for every screenshot, except for some display screenshot that only allow accessing system operation information that cannot be changed.

Table A - FLASHING SYMBOLS

MOVING ICONS		
When the mouse cursor is blinking...	Pressing the button...	What happens is...
⊕	↓ or ↑	You can access the following or previous screenshot
	←	You can access modifiable fields within the current screenshot
⌂	Esc	You can go back to the previous menu
*	↓ or ↑	You can access the following field (where present)
	←	You can access the sub menus
VALUE FIELDS		
example: 24°C	↓ or ↑	You can decrease / increase the value (e.g.: from "24°C" to "25°C")
	←	You can confirm the value and proceed to the next field
TEXT FIELDS		
example: Off/ On	↓ or ↑	You can change the current setting (e.g.: from "ON" to "OFF")
	←	You can confirm the value expressed by the text and proceed to the next field





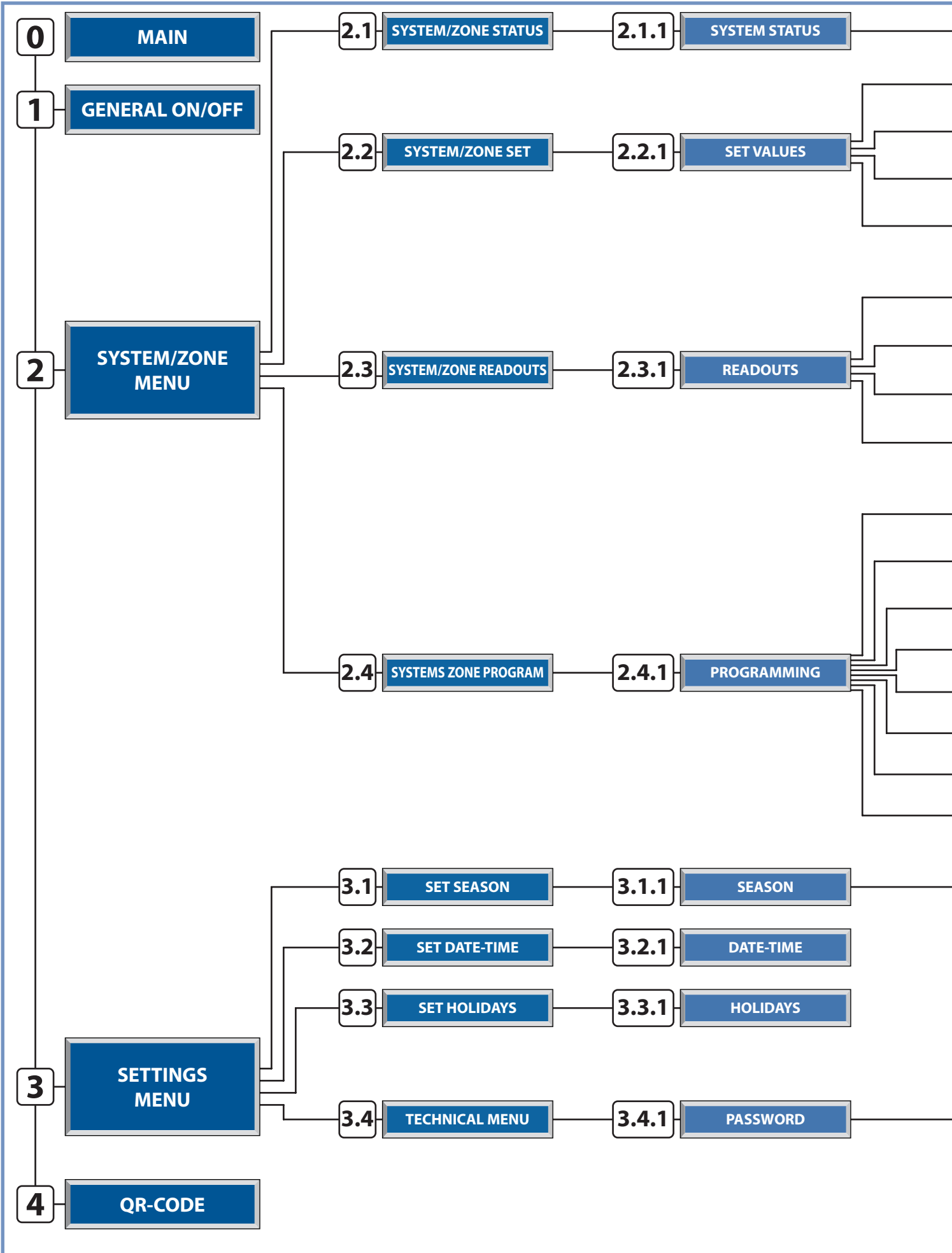

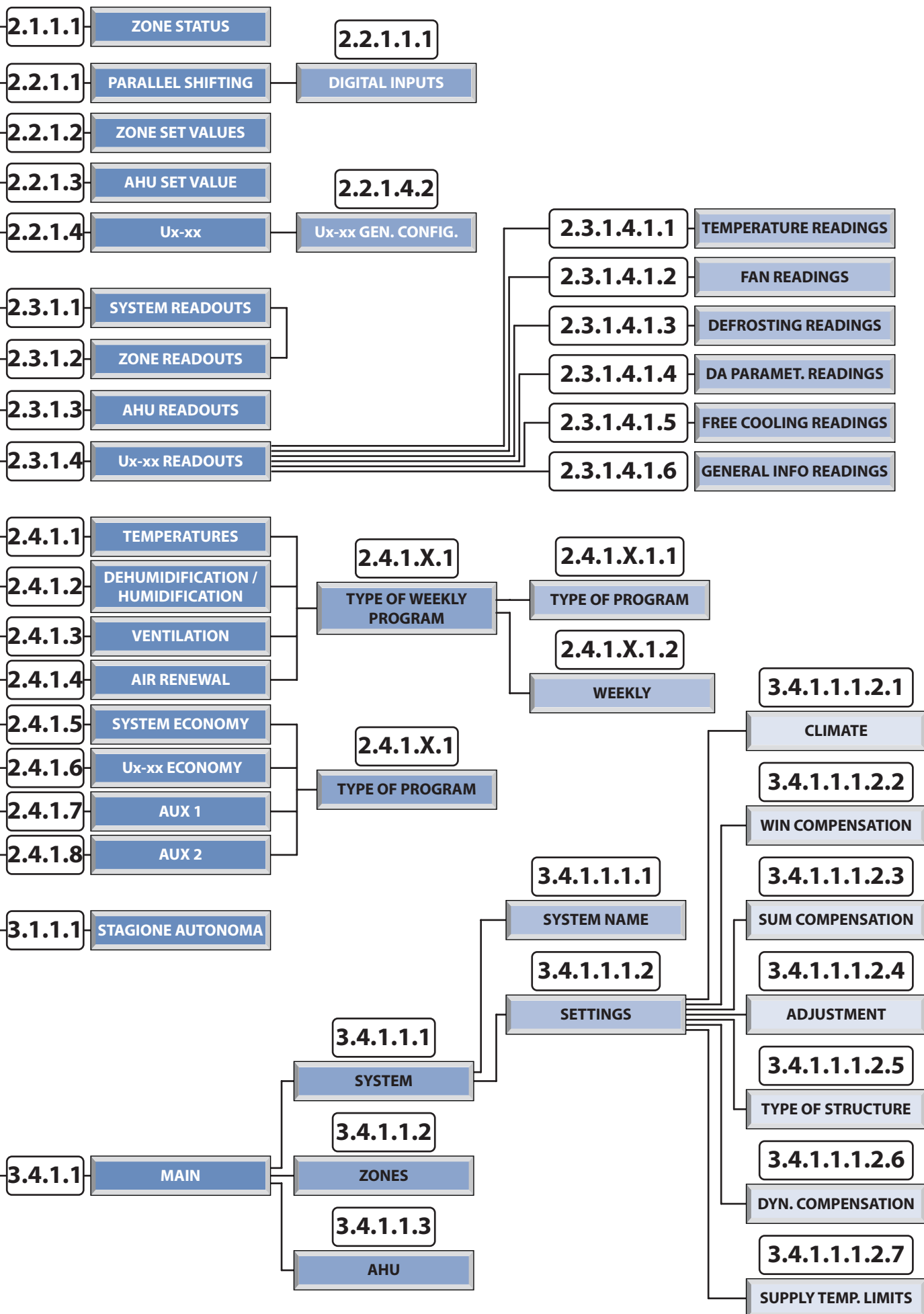



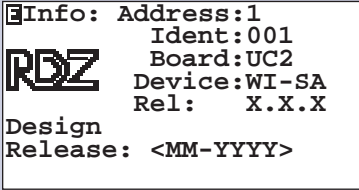

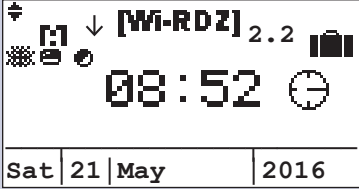

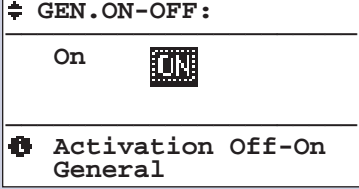

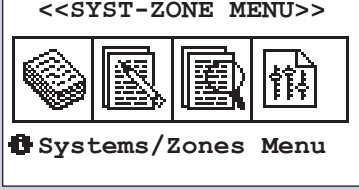

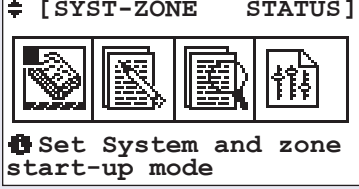

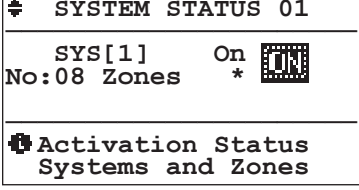

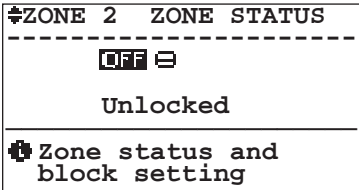

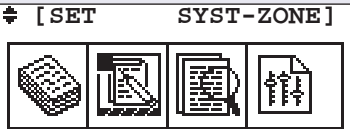
SUMMARY OVERVIEW OF THE SCREENSHOT







TO...	THIS IS THE SCREENSHOT TO REFER TO	
<p>INFORMATION ON: Type of Hardware, board address, type of program, program version.</p>		
<p>DISPLAY THE MAIN SCREENSHOT Program version, Season, General Activation, Date.</p>		
<p>SWITCH OFF ALL SYSTEMS Off: Control unit general switch-off On: Control unit general start-up</p> <p>N.B. Screenshot present only in configurations with more than one mixing system</p>		
<p>MANAGE SYSTEMS AND ZONES System-Zone function selection menu: Status / Set / Readouts / Programming</p>		
<p>MODIFY THE SYSTEM (ON/OFF) AND ZONE (ON/OFF/PGM/PGM-MAN) STATUS</p>		
<p>MODIFY THE SYSTEM STATUS Off: System and associated zones switch-off (the system is automatically activated when the control unit detects a temperature lower than 5°C – anti-freeze function) On: System activation.</p>		
<p>MODIFY A ZONE STATUS AND ITS REMOTE TERMINAL BLOCK Off: Zone switch-off. Man: Zone start-up according to the settings. Pgm: Zone in programming mode (Zone start-up according to the timeslots and set point set in the programming menu). Pgm/Man: Zone in manual programming mode (Zone start-up according to the timeslots set in the programming menu and temperatures set manually).</p> <p>Unlocked: Allows modifying the settings from the remote terminals. Locked: Inhibits the option to modify the settings from the remote terminals.</p>		

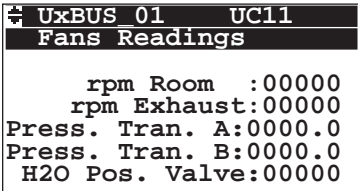
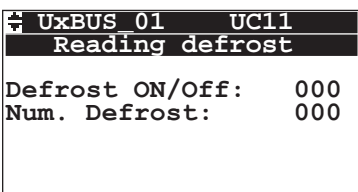
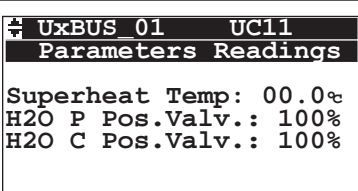
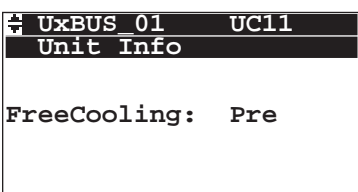
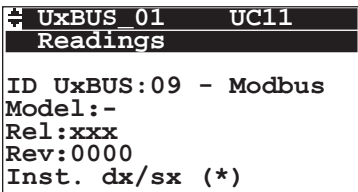
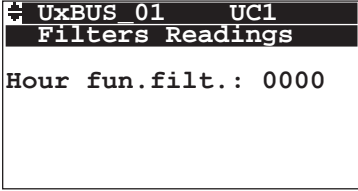
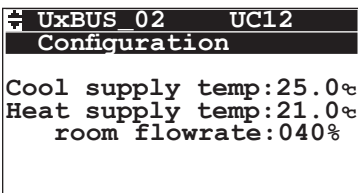
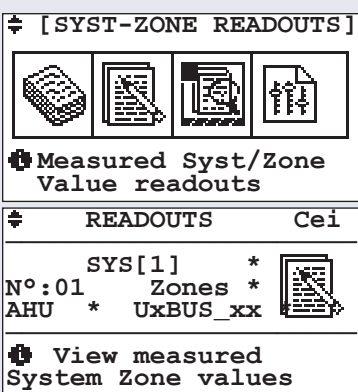

<p>MODIFY SYSTEM, ZONE AND AHU PARAMETERS</p>	<p>2.2 2.2.1</p>	 <p>➤ [SET SYST-ZONE]</p> <p>➤ Set system and zone values</p> <p>➤ SET VALUES</p> <p>SYS[1] * </p> <p>N°:02 Zones *</p> <p>AHU * UxBUS_xx</p> <p>➤ Modify system & Zone Set values</p>
<p>MODIFIED PARALLEL SHIFTING</p> <p>This parameter manages the shift that can be introduced in the system delivery temperature calculation obtained through the compensation line.</p>	<p>2.2.1.1</p>	<p>➤SYS[1] Set-Sum</p> <p>Parall shift: 0.0°C</p> <p>ID-Remote:*</p> <p>➤ System set</p>
<p>MODIFY DIGITAL INPUTS</p> <p>Digital input modification by changing their intended use and identification of the contact status with idle component.</p>	<p>2.2.1.1.1</p>	<p>➤ Type of signal</p> <p>Wi-MI digital inp.</p> <p>N/N</p> <p>0/0</p> <p>ID1:Season →NO</p> <p>ID2:General On-Off →NO</p> <p>ID3:-----→NO</p> <p>ID4:-----→NO</p>
<p>MODIFY ZONE PARAMETERS</p> <p>Temperature and humidity parameter setting (if dehumidifier is present) of the zones in MANUAL or PROGRAMMING MANUAL operation.</p>	<p>2.2.1.2</p>	<p>➤ZONE 1 Set Sum Val</p> <p>22.0 55</p> <p>25.0% 55%</p> <p>➤ Setting 24h manual setpoints</p>
<p>CHANGE AHU PARAMETERS</p> <p>Activate or deactivate the integration function and set the relevant functioning temperatures; if there is an air quality sensor, set the reference value of CO2 to activate the renewal function.</p>	<p>2.2.1.3</p>	<p>➤AHU[1] Set AHU</p> <p>Act.Sum:No Act.Win:No</p> <p>Integr. diff:03.0°C</p> <p>Neutral air:22.0°C</p> <p>CO2:30%</p> <p>➤ AHU parameter set</p>
<p>Ux READINGS/SETTINGS:</p> <p>Unit type selected (Ux) and identification address.</p> <p>CO2: Displays the value of Co2 (with probe A present)</p>	<p>2.2.1.4</p>	<p>➤ UxBUS_02 UC12</p> <p>Readings: : *</p> <p>Settings: : *</p> <p>CO2 : 26.8%</p> <p>- Id-01</p> <p>Ver.: 000 Rev. 0000</p>
<p>TEMPERATURE READINGS for UxBUS_xy (xy = unit index)</p> <p>Supply Temp: Delivery air temperature.</p> <p>Water Temp: Inflow water temperature.</p> <p>Condens Temp: Gas condensation temperature.</p> <p>Evapor Temp: Gas evaporation temperature.</p> <p>External temp: Reading of the outside temperature</p> <p>Operation status</p> <p>: The darkening of the square background indicates that the function is ON</p> <p>Dehumidification:  = ON Free-cooling:  = ON</p> <p>Integration:  = ON Boost:  = ON</p> <p>Renewal:  = ON Economy:  = ON</p> <p>Ventilation:  = ON</p>	<p>2.2.1.4.1.1</p>	<p>➤ UxBUS_01 UC11</p> <p>Temperature Readings</p> <p>Supply temp.:000.0°C</p> <p>Water temp. :000.0°C</p> <p>Condens.temp.:000.0°C</p> <p>Evapor.temp. :000.0°C</p> <p>Extern.temp. :000.0°C</p> <p></p>

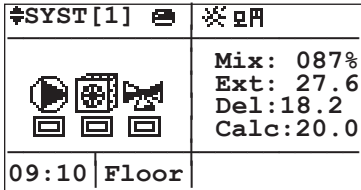
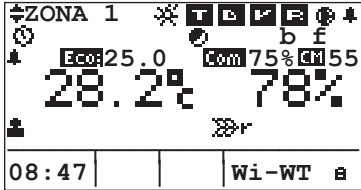
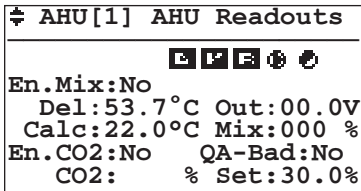
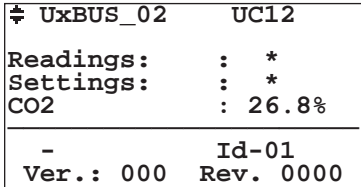
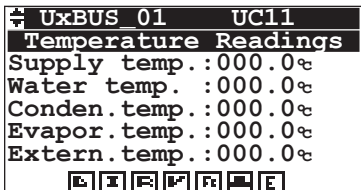
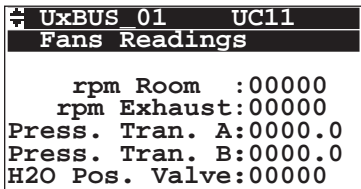
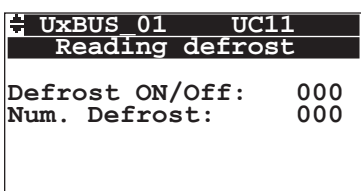
<p>FAN READINGS for selected Ux: rpm Room: Rotation speed of the supply fan. rpm Exhaust: Rotation speed of the expulsion fan. Press Tran. A: Transducer A differential air pressure reading Press Tran. B: Transducer B differential air pressure reading H2O Pos. Valve: H2O Valve position.</p>	<p>2.2.1.4.1.2</p>	
<p>DEFROSTING READINGS for selected Ux: Defrost ON/Off: It shows the defrosting status Num. Defrost: It shows the number of defrosting cycles already performed</p>	<p>2.2.1.4.1.3</p>	
<p>DA PARAMETERES READINGS for selected Ux: Superheat Temp: Overheating temperature H2O P Pos.Valv.: Position of the water valve for the pre-treatment coil H2O C Pos.Valv.: Position of the water valve of the condensation coil</p>	<p>2.2.1.4.1.4</p>	
<p>UNIT INFO READINGS: Free Cooling connection type. Pre: Free Cooling air inlet before coils. Post: Free Cooling air inlet after coils.</p>	<p>2.2.1.4.1.5</p>	
<p>GENERAL INFORMATION for SELECTED Ux: ID Ux: Modbus net index. Model: Ux Model. Ver: Software version installed. Rev: Software revision installed. Inst. dx/sx: Left / right installation (* Only for WHR units).</p>	<p>2.2.1.4.1.6</p>	
<p>General Information on the selected Ux: Hour fun.filt.: Indicates the machine operating hours for the filters in use. (* Only for WHR units).</p>	<p>2.2.1.4.1.7</p>	
<p>GENERAL SETTINGS for SELECTED Ux: Cool supply temp: Summer supply temperature setting. Heat supply temp: Winter supply temperature setting. Room flow rate: Room flow rate setting.</p>	<p>2.2.1.4.2</p>	
<p>READ THE SYSTEM, ZONE AND AIR HANDLING UNIT PARAMETERS</p>	<p>2.3 2.3.1</p>	

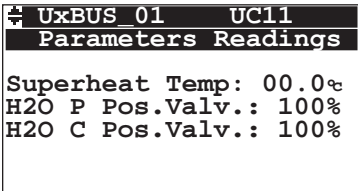
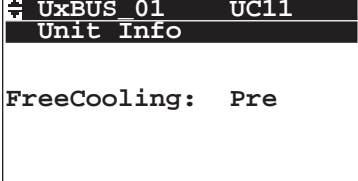
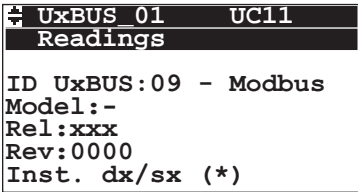
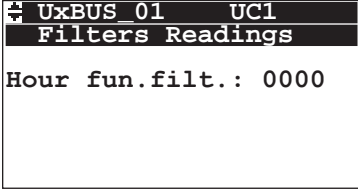
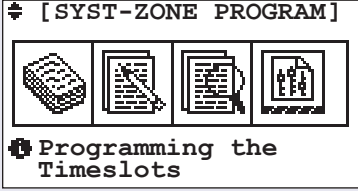
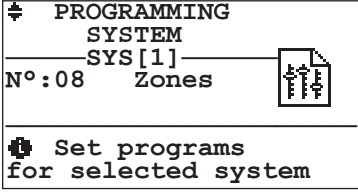
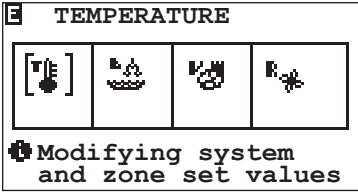
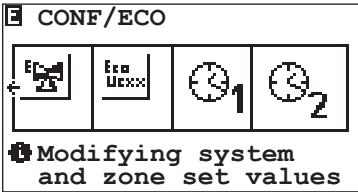
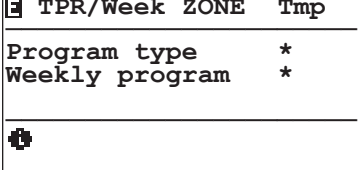
<p>READ SYSTEM PARAMETERS</p> <p>Mix: Mixing valve activation percentage Ext: External temperature Del: Delivery Temperature Calc: Calculated Delivery Temperature System pump activation status Energy source (boiler-chiller)</p>	<p>2.3.1.1</p>	
<p>READ ZONE PARAMETERS</p> <p>Zone status: Off / On / Pgm / Pgm-Man; Start-up status T: Temperature / D: Dehumidification / H: Humidification / [V: Ventilation / R: Air Renewal]; b: Boost; f: Free Cooling; Com: Comfort Programming CM: Comfort Index Eco: Economy Programming; Measured Temperature; Measured Humidity (only for TA/H sensors)</p>	<p>2.3.1.2</p>	
<p>READ AHU PARAMETERS</p> <p>Start-up status [D: Dehumidification/ H: Humidification / V: Ventilation / R: Air Renewal] En.Mix: Mixing calculation enabled Del: Value detected by the duct sensor Cal: Calculated mixing Temperature Out: Mixing valve output value Mix: Mixing valve opening percentage En.CO₂: Presence of the air quality sensor CO₂: CO₂ percentage value detected by the duct sensor QA-Bad: Too much CO₂ in the air Set: Threshold for the quality of clean air</p>	<p>2.3.1.3</p>	
<p>Ux READINGS/SETTINGS: Unit type selected (Ux) and identification address.</p> <p>CO2: Displays the value of Co2 (with probe A present)</p>	<p>2.3.1.4</p>	
<p>TEMPERATURE READINGS for UxBUS_xy (xy = unit index)</p> <p>Supply Temp: Delivery air temperature. Water Temp: Inflow water temperature. Conden Temp: Gas condensation temperature. Evapor Temp: Gas evaporation temperature. External temp: Reading of the outside temperature Operation status indicates that the function is ON</p> <p>Dehumidification: = ON Free-cooling: = ON Integration: = ON Boost: = ON Renewal: = ON Economy: = ON Ventilation: = ON</p>	<p>2.3.1.4.1.1</p>	
<p>FAN READINGS for selected Ux:</p> <p>rpm Room: Rotation speed of the supply fan. rpm Exhaust: Rotation speed of the expulsion fan. Press Tran. A: Transducer A differential air pressure reading Press Tran. B: Transducer B differential air pressure reading H2O Pos. Valve: H2O Valve position.</p>	<p>2.3.1.4.1.2</p>	
<p>DEFROSTING READINGS for selected Ux:</p> <p>Defrost ON/Off: It shows the defrosting status Num. Defrost: It shows the number of defrosting cycles already performed</p>	<p>2.3.1.4.1.3</p>	

<p>DA PARAMETERES READINGS for selected Ux:</p> <p>Superheat Temp: Overheating temperature H2O P Pos.Valv.: Position of the water valve for the pre-treatment coil H2O C Pos.Valv.: Position of the water valve of the condensation coil</p>	2.3.1.4.1.4	
<p>UNIT INFO READINGS:</p> <p>Free Cooling connection type. Pre: Free Cooling air inlet before coils. Post: Free Cooling air inlet after coils.</p>	2.3.1.4.1.5	
<p>GENERAL INFORMATION for SELECTED Ux:</p> <p>ID Ux: Modbus net index. Model: Ux Model. Ver: Software version installed. Rev: Software revision installed. Inst. dx/sx: Left / right installation (* Only for WHR units).</p>	2.3.1.4.1.6	
<p>General Information on the selected Ux:</p> <p>Hour fun.filt.: Indicates the machine operating hours for the filters in use. (* Only for WHR units).</p>	2.3.1.4.1.7	
<p>WEEKLY PROGRAM</p>	2.4	
<p>SELECT THE SYSTEM TO BE PROGRAMMED</p>	2.4.1	
<p>SELECT PROGRAMMING</p> <p>T: Temperature D: Dehumidification (summer) / H: Humidification (winter) V: Ventilation R: Air renewal E: System economy ECO UCxx: UCxx economy AUX1: Auxiliary chrono 1 AUX2: Auxiliary chrono 2</p>	<p>2.4.1.1 2.4.1.2 2.4.1.3 2.4.1.4 2.4.1.5 2.4.1.6 2.4.1.7 2.4.1.8</p>	 
<p>MODIFY A PROGRAM OR SET A WEEK</p>	<p>2.4.1.1.1 2.4.1.2.1 2.4.1.3.1 2.4.1.4.1</p>	

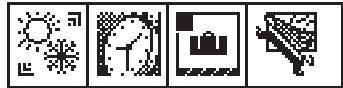
<p>SET A PROGRAM Standard (STD), Weekday (WD), Weekend (WE), etc...</p> <p>Copy a program</p>	<p>2.4.1.1.1 2.4.1.2.1.1 2.4.1.3.1.1 2.4.1.4.1.1</p>	<table border="1"> <tr> <td>☑</td> <td>From</td> <td>To</td> <td>ECO</td> <td>27.0</td> </tr> <tr> <td>Temp</td> <td>07:30</td> <td>12:00</td> <td></td> <td>25.0</td> </tr> <tr> <td>Sum</td> <td>13:00</td> <td>17:00</td> <td></td> <td>24.0</td> </tr> <tr> <td>Std</td> <td>19:00</td> <td>22:30</td> <td></td> <td>26.0</td> </tr> </table> <p>Program timeslots</p>	☑	From	To	ECO	27.0	Temp	07:30	12:00		25.0	Sum	13:00	17:00		24.0	Std	19:00	22:30		26.0					
☑	From	To	ECO	27.0																							
Temp	07:30	12:00		25.0																							
Sum	13:00	17:00		24.0																							
Std	19:00	22:30		26.0																							
<p>ASSOCIATE A PROGRAM TO THE DAYS OF THE WEEK</p> <p>Copy a weekly program</p>	<p>2.4.1.1.1.2 2.4.1.2.1.2 2.4.1.3.1.2 2.4.1.4.1.2</p>	<table border="1"> <tr> <td>☑</td> <td>ZONE 1</td> <td>Temp</td> <td>☑</td> </tr> <tr> <td>MO:</td> <td>Std</td> <td>TU:</td> <td>Std</td> </tr> <tr> <td>WE:</td> <td>Std</td> <td>TH:</td> <td>Std</td> </tr> <tr> <td>FR:</td> <td>Std</td> <td>SA:</td> <td>Fer</td> </tr> <tr> <td>SU:</td> <td>Fes</td> <td></td> <td></td> </tr> </table> <p>Associate a program To a day of the week</p>	☑	ZONE 1	Temp	☑	MO:	Std	TU:	Std	WE:	Std	TH:	Std	FR:	Std	SA:	Fer	SU:	Fes							
☑	ZONE 1	Temp	☑																								
MO:	Std	TU:	Std																								
WE:	Std	TH:	Std																								
FR:	Std	SA:	Fer																								
SU:	Fes																										
<p>SET THE TIMESLOTS FOR ECONOMY MODE ON THE SELECTED SYSTEM</p>	<p>2.4.1.5.1</p>	<table border="1"> <tr> <td>☑</td> <td>SYS[1]</td> <td></td> <td>ECO</td> <td>NO</td> </tr> <tr> <td></td> <td>FROM</td> <td>TO</td> <td></td> <td>05.0</td> </tr> <tr> <td>IMP</td> <td>07:30</td> <td>12:00</td> <td></td> <td></td> </tr> <tr> <td>ECO</td> <td>13:00</td> <td>17:00</td> <td></td> <td></td> </tr> <tr> <td></td> <td>19:00</td> <td>22:30</td> <td></td> <td></td> </tr> </table> <p>Program timeslots</p>	☑	SYS[1]		ECO	NO		FROM	TO		05.0	IMP	07:30	12:00			ECO	13:00	17:00				19:00	22:30		
☑	SYS[1]		ECO	NO																							
	FROM	TO		05.0																							
IMP	07:30	12:00																									
ECO	13:00	17:00																									
	19:00	22:30																									
<p>SET THE TIMESLOTS FOR ECONOMY MODE ON Ux</p>	<p>2.4.1.6.1</p>	<table border="1"> <tr> <td>☑</td> <td>AHU[1]</td> <td></td> <td>ECO</td> </tr> <tr> <td></td> <td>FROM</td> <td>TO</td> <td></td> </tr> <tr> <td>AHU</td> <td>07:30</td> <td>12:00</td> <td>20</td> </tr> <tr> <td>ECO</td> <td>13:00</td> <td>17:00</td> <td>50</td> </tr> <tr> <td></td> <td>19:00</td> <td>22:30</td> <td>30</td> </tr> </table> <p>Program timeslots</p>	☑	AHU[1]		ECO		FROM	TO		AHU	07:30	12:00	20	ECO	13:00	17:00	50		19:00	22:30	30					
☑	AHU[1]		ECO																								
	FROM	TO																									
AHU	07:30	12:00	20																								
ECO	13:00	17:00	50																								
	19:00	22:30	30																								
<p>SET THE TIMESLOTS ACTIVATION FOR TWO EXTERNAL DEVICES THROUGH INTEGRATED RELAYS</p>	<p>2.4.1.7.1 2.4.1.8.1</p>	<table border="1"> <tr> <td>☑</td> <td>AUX 1</td> <td></td> <td>ECO</td> <td>NO</td> </tr> <tr> <td></td> <td>FROM</td> <td>TO</td> <td></td> <td></td> </tr> <tr> <td>ECO</td> <td>07:30</td> <td>12:00</td> <td></td> <td></td> </tr> <tr> <td></td> <td>13:00</td> <td>17:00</td> <td></td> <td></td> </tr> <tr> <td></td> <td>19:00</td> <td>22:30</td> <td></td> <td></td> </tr> </table> <p>Program timeslots</p>	☑	AUX 1		ECO	NO		FROM	TO			ECO	07:30	12:00				13:00	17:00				19:00	22:30		
☑	AUX 1		ECO	NO																							
	FROM	TO																									
ECO	07:30	12:00																									
	13:00	17:00																									
	19:00	22:30																									
<p>CHANGE SYSTEM AND PROGRAM SETTINGS</p>	<p>3</p>	<p><< SETTINGS >></p> <table border="1"> <tr> <td></td> <td></td> <td></td> <td></td> </tr> </table> <p>Technical Menu</p>																									
<p>SET THE SEASON (SUMMER/WINTER)</p>	<p>3.1 3.1.1</p>	<p>[SET SEASON]</p> <table border="1"> <tr> <td></td> <td></td> <td></td> <td></td> </tr> </table> <p>Set season mode</p> <table border="1"> <tr> <td colspan="2">SEASON</td> </tr> <tr> <td>Winter</td> <td> </td> </tr> </table> <p>Press PRG for Manual/Automatic</p>					SEASON		Winter																		
SEASON																											
Winter																											
<p>SET AUTOMATIC OR MANUAL CHANGE OF SEASON</p> <p>N.B. only for systems hydraulically set for automatic operation</p>	<p>3.1.1.1</p>	<table border="1"> <tr> <td>☑</td> <td>Automatic Season</td> </tr> <tr> <td></td> <td>Auto</td> </tr> <tr> <td></td> <td>Set change:22.0 °C</td> </tr> <tr> <td></td> <td>Sampling:030 sec</td> </tr> <tr> <td></td> <td>Neutral Temp.:1.0 °C</td> </tr> </table> <p>Change mode</p>	☑	Automatic Season		Auto		Set change:22.0 °C		Sampling:030 sec		Neutral Temp.:1.0 °C															
☑	Automatic Season																										
	Auto																										
	Set change:22.0 °C																										
	Sampling:030 sec																										
	Neutral Temp.:1.0 °C																										

<p>SET DATE AND TIME</p>	<p>3.2 3.2.1</p>	<p>☛ [SET DATE-TIME]</p>  <p>☛ Set Date and Time of the control unit</p> <pre> E -hh- -mm- Fri 16 37 -dd--MM- -YY- 05 November 2010 </pre> <p>☛ Modify date values hh-mm dd-MM-YYY</p>
<p>SET A PERIOD WHEN THE SYSTEM MUST REMAIN OFF (E.G.: HOLIDAYS)</p>	<p>3.3 3.3.1</p>	<p>☛ [SET HOLIDAYS]</p>  <p>☛ Set holidays Holiday Timer</p> <pre> E HOLIDAYS Enable From:24 December 2010 To:05 January 2011 </pre> <p>☛ Set holidays timer</p>
<p>MODIFY SYSTEM NAMES OR FUNCTIONAL PARAMETERS</p>	<p>3.4</p>	<p>☛ [TECHNICAL MENU]</p>  <p>☛ Access TECHNICAL menu</p>
<p>SELECT WHAT TO MODIFY System Zone Dehumidifiers</p>	<p>3.4.1.1</p>	<pre> E <UM> Main System: * Zones: * Dehumidifiers: * </pre>
<p>MODIFY SYSTEM PARAMETERS Modify system name Modify settings: Climate Winter climate Summer climate Adjustment Type of structure (delta structure) Dynamic compensation</p>	<p>3.4.1.1.1 3.4.1.1.1.1 3.4.1.1.1.2</p>	<pre> E <UM> System Names: * Settings * </pre> <p>☛ SYS Name 01</p> <pre> S Y S [1] </pre> <p>☛SYS[1] 01</p> <p>Setting</p> <p>☛ Definition of parameters for mixing</p>

<p>MODIFY SYSTEM PARAMETERS</p> <p>Modify system name Modify settings: Climate Winter climate Summer climate Adjustment Type of structure (delta structure) Dynamic compensation</p>	<p>3.4.1.1.1.2.1 3.4.1.1.1.2.2 3.4.1.1.1.2.3 3.4.1.1.1.2.4 3.4.1.1.1.2.5 3.4.1.1.1.2.6 3.4.1.1.1.2.7</p>	<pre> #SYS[1] Climate 01 Type:External/Room Season:Win + Sum: Climate and season #SYS[1] WinComp 01 Min Max Off TExt:-05.0 20.0 0.0 TDel:45.0 22.0 Winter compensation curve #SYS[1] SumComp 01 Min Max Off TExt:23.0 32.0 0.0 TDel:20.0 15.0 Summer compensation curve #SYS[1] Adjustment 01 <<Pgm/Man>> tmp Hum Summer: 2.0 10 Winter: -2.0 -10 Eco. adjustment Manual program #SYS[1] DELTA STR.01 Delta Structure: 2.0 Type of screed #SYS[1] DynComp 01 Enable:Yes Pilot:01 KDSum:3 KDWin:03 TMin:10.0 TMax:50.0 Room dynamic compensation # Supply temp. limits SUMMER WINTER TMin:10.0 TMax:50.0 Room dynamic compensation </pre>
<p>MODIFY ZONE PARAMETERS</p> <p>Modify zone name</p>	<p>3.4.1.1.2</p>	<pre> # ZONE Name 01 Z O N E 1 </pre>
<p>MODIFY DEHUMIDIFIER PARAMETERS</p> <p>Modify dehumidifier name</p>	<p>3.4.1.1.3</p>	<pre> # DEHUMID. Name 01 A H U [1] </pre>
<p>QR-CODE / MANUALS DOWNLOAD</p> <p>Scan the QR code to access updated manuals in digital format.</p>	<p>4</p>	<p># DOWNLOAD MANUALS</p> 



ACTIONS ON THE MENUS

In the following pages are described all the user menus. The screenshot is presented with a brief description of its features and symbols.

EXAMPLE

ADDRESS 2 SYSTEM-ZONE MENU/ 2.2 SYSTEM-ZONE SET / 2.2.1 SET VALUES/

2.2.1.2 ZONE SET VALUES SCREENSHOT

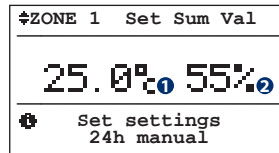

By accessing the "Set Sum. (Summer)/Win (Winter) values" submenu, you can establish the Temperature/Humidity comfort values (the latter only in summer) for the various zones. These values come into play when the zone activation status is "Man" (see 2.1.1.1 - "Zone Status"). The zone and dehumidifier activation behaviour, together with the activation differentials and setpoints, are schematically summarised in figures 2.2.1, 2.2.2, 2.2.3 in the following page, where the temperature and humidity values of the relative season are considered. As for the sets, the system "On" and "Off" statuses are indicated.

Table of variables	
No.	Description
1	Temperature value
2	Humidity value

Table of movements		
Button	Screenshot	
Esc	2.2.1	SET VALUES

The following are represented:

- on top the path to access the screenshot.
- in the centre a graphical representation of the screenshot with the relative interpretation of the variables.
- on the left a description of the screenshot and the directions for use.
- on the right two tables:
 - the first one describes the variables in the screenshot and the possible options. The example shows the temperature and humidity values that can be modified.
 - The second represents the screenshot that can be accessed by pressing the various buttons. The example shows the screenshot that can be accessed; by pressing "ESC" you access the screenshot "2.2.1 Set Values".

SYMBOLS

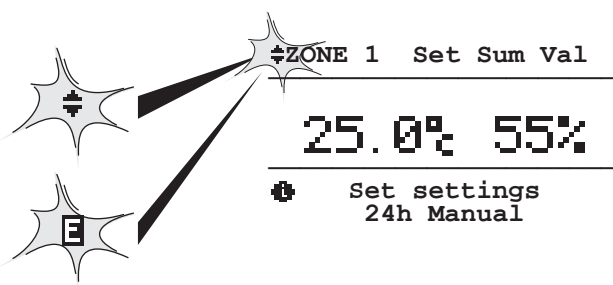

The cursor flashes in a different way whether there are:
- several systems in such case you can scroll through them)
- only one system .



By pressing the UP and DOWN arrows, the values shift from "off" to "on" and viceversa.

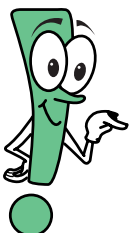

For further information on button and screenshot functions, refer to the first few pages of the manual marked with the thumb index: INFO



```

Info: Address:1
      Ident:001
      Board:SN
      Device:WI-SA
      Rel: X.X.X
RDZ
Release: <DD-MM-YYYY>
    
```

By pressing **ESC+DOWN** simultaneously, you can assess the general information menu.

In this section you can view in succession:

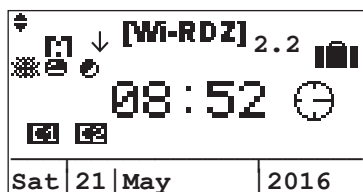
- Address :Plan address.
- Ident : Supervisor address.
- Device : Name of the controller category.
- Rel : Programme release.
- Issue : Date of issue for the software.



This screenshot is displayed in the following situations:

- upon system start-up;
- after a settable amount of user inactivity time (the motion icon in the top left corner of the display flashes).

Warning!

This screenshot displays the system status and it cannot be modified.

For example, to activate the "Holidays - holiday timer" function, you need to access the "Holidays" screenshot ("3 Settings Menu" -> "3.3 Holidays") pressing the "ARROW DOWN", and set the activation and the start and the end of this period.

Table of icons	
Icon	Description
↓	The symbol ↓ means that the protocol of the interface connected with J5 is P-LAN.
	The symbol ↑ means that the protocol of the interface connected with J5 is Modbus
⊠	If this icon is visible, the "Antifreeze" mode is activated.
X.X	Software version
☼	Season ☼ = Winter ☼ = Summer
⊞	Control unit activation status ⊞ = Activated ⊞ = Deactivated
⊞	If this icon is visible, the "energy source" mode is activated.
⊞	Output C1 activated
⊞	Output C2 activated
⊞	Control unit in "holiday" mode

Table of movements		
Button	Screenshot	
⊞	2.4	PROGRAMMING
↑	3	SETTINGS MENU
←	2.3	READOUTS
↓	1	GENERAL ON-OFF

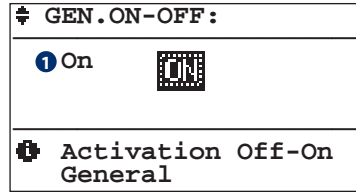

Warning! This screenshot is displayed only if the control unit manages more than one mixing system.

On: implies the activation of all the functions according to the settings of the various systems and zones configured.

Off: if you choose to deactivate the systems (general Off), everything will stop.

Should you wish to reactivate the system (general ON), the systems will start operating again according to the previously set status.

The activation mode is summarised in **“System and associated zones behaviour”**.

Only the zones belonging to the system that were active before turning the system OFF are restored in their functionality.

Table of variables

No.	Description
1	General system status ON OFF

Table of movements

Button	Screenshot
	0 MAIN
	0 MAIN
	1 GENERAL ON-OFF (Modify values)
	2 SYSTEM/ZONE MENU

Behaviour of the system and associated zones

STATUS								FUNCTION ACTIVATION				
General ON-OFF		System ON-OFF		ON-OFF-PGM-PGM/MAN Zone				SYSTEM STATUS (1)	ZONE STATUS (2)			
OFF	ON	OFF	ON	OFF	ON	PGM	PGM/MAN		Temp.	Humidity	Ventil.	Renewal
X		*	*	*	*	*	*	OFF	OFF	OFF	OFF	OFF
	X	X		*	*	*	*	OFF	OFF	OFF	OFF	OFF
	X		X	X				ON	OFF	OFF	OFF	OFF
	X		X		X			ON	SET	SET	PGM	PGM
	X		X			X		ON	PGM	PGM	PGM	PGM
	X		X				X	ON	SET + PGM	SET + PGM	PGM	PGM

Where the symbols used in the table have the following meaning:

X: situation of the setting.

*****: irrelevant setting situation.

(1) SYSTEM STATUS:

- **OFF:** Deactivated system. Mixing is disabled and all the zones associated to the system are deactivated. Operates in ANTIFREEZE mode during winter.
- **ON:** Activated system. Mixing is enabled according to the calculated temperature setpoint. The system zones operate according to their set status.

(2) ZONE STATUS:

- **OFF:** Deactivated zone function.
- **SET:** The zone is activated or deactivated according to the manual set. This status refers to both the temperature and humidity.
- **PGM:** Activation occurs according to the timeslots and corresponding sets.
- **SET+PGM:** Activation occurs according to the timeslots and manual sets.

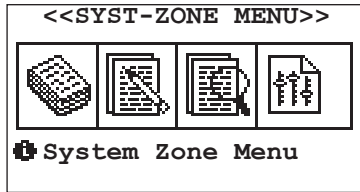

Table of movements		
Button	Screenshot	
Esc	0	MAIN
↑	1	GENERAL ON-OFF
←	2.1	SYSTEM/ZONE STATUS
↓	3	SETTINGS

Through menu 2 "System/Zone Menu" you can:

menu 2.1 = define the system operating status (On/Off) and of the zone it belongs to (Off/Del/Pgm).

menu 2.2 = modify operating parameters that characterise the system and the zones (if set to Manual - MAN).

menu 2.3 = read all the operating values of the various systems and correlated zones.

menu 2.4 = set every week the required temperature, humidity and functions (air renewal or ventilation) for every hour of the day in the various zones (if set during programming - PGM).

ADDRESS 2 SYSTEM-ZONE MENU

2.1

SYSTEM/ZONE STATUS SCREENSHOT

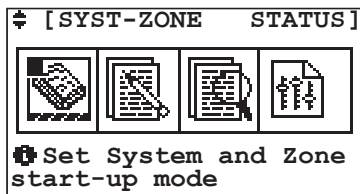

Table of movements		
Button	Screenshot	
Esc	0	MAIN
↑	2	SYSTEM/ZONE MENU
←	2.1.1	SYSTEM STATUS
↓	2.2	SYSTEM/ZONE SET

Menu 2.1 "System/zone status" allows defining the operating status of the system and its zones.

Example

A house with a system associated to every floor:

System 1 - Ground Floor

System 2 - First Floor

System 3 - Second Floor

etc.

Every system (floor) is divided into zones that can be managed separately:

System 1 (ground floor):

Zone 1 - kitchen

Zone 2 - living room

Zone 3 - laundry

etc.

System 2 (first floor):

Zone 1 - room 1

Zone 2 - room 2

Zone 3 - room 3

System 3 (second floor):

Zone 1 - bathroom

Zone 2 - room 4

Zone 3 - study

For every system you can define the status (ON/OFF) and for every zone you can define the type of operation (OFF/MAN/PGM).

OFF: zone Deactivated.

MAN: the zone is activated in Manual mode with the settings configured in menu 2.2 "System/Zone Set".

PGM: the zone operates in Programmed mode with the settings configured in menu 2.4 "Programming".

PGM/MAN: This zone functions in programming mode according to timeslots set in menu 2.4 "Programming" and temperature/humidity set in menu 2.2 "System / Zone Setting".

2.1.1 SYSTEM STATUS SCREENSHOT

This screenshot allows defining the operating status (On or Off) of the displayed system (e.g.: SYS[1]).

If the control unit manages more than one system, the screenshot pertaining to the configured systems will be displayed in sequence.

The cursor flashes on the top left corner; by pressing "ENTER" you can move it in the text field: by pressing "ARROW UP" and "ARROW DOWN" you can modify the setting in the field (e.g.: from "On" to "Off").

- **"Off" setting:** switches off the system (maintaining the ANTIFREEZE* function) and all the zones associated to it.

- **"On" setting:** starts the system according to the operating status of the associated zones.

Setting the system to "On" ensures the setpoint values set by the user in the zones in timeslots, outside of which the temperature setpoint attenuation shall be applied.

*** ANTIFREEZE FUNCTIONS:**

If the system is OFF and the control unit detects a zone with a temperature below 5°C, the system is activated to take it to 6°C. This function prevents damage to the system caused by frost.

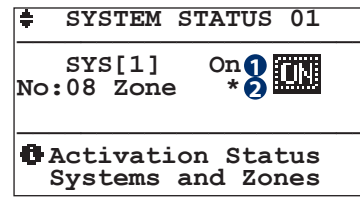

Table of variables	
No.	Description
1	System status ON OFF
2	Allows accessing the settings of the zones belonging to the system

Table of movements	
Button	Screenshot
Esc	2.1 SYSTEM/ZONE STATUS
← ← ←	2.1.1.1 ZONE STATUS

2.1.1.1 ZONE STATUS SCREENSHOT

This screenshot allows defining the operating status of the selected zone.

The "On" status of the system allows the zones to operate according to the set operating status.

The OFF status of the zones involves its deactivation: this status automatically switches off the zone, regardless of the set status of the selected zone.

The MAN status enables zone operation according to the measured Temperature/Humidity and set setpoint (menu 2.2 "System / Zone Set").

The PGM status enables zone operation according to the timeslots and the Temperature/Humidity programming settings (menu 2.4 "Programming").

The status PGM activates the zone relating to the timeslots (menu 2.4 "Programming") and to the manual settings for Temperature/Humidity (menu 2.2 "System/Zone Set").

The "Locked" status locks setpoint modification from bus or wireless terminals.

The "Unlocked" status allows setpoint modification from bus or wireless terminals.

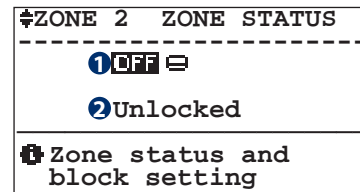

Table of variables	
No.	Description
1	Zone status OFF = Off MAN = Manual PGM = Programming PGM = Manual programming
2	Sensor block: appears only in presence of wireless or bus terminals.

Table of movements	
Button	Screenshot
Esc	2.1.1 SYSTEM STATUS

Warning! The zone operating status is always related to the status of the system associated to it! If, for example, the system is Off, all the correlated zones will be deactivated.

2.2 SYSTEM/ZONE SET SCREENSHOT

Menu 2.2 "System/Zone Set" allows modifying the operating parameters that characterise the system and the zones.

System variations: you can set the variation to introduce in the system delivery temperature calculation (parallel shift).

Zone variations: if the zone operates in Manual mode, you can set at which temperature and humidity it must be configured.

Example:

If you want "zone 1" to operate in Manual mode (to be set through menu 2.1 "System / Zone Status"), at 24°C -> you must set this value in menu 2.2.1.2 "Zone set values".

When in "zone 1" the temperature drops below the set value, heating is activated and will turn off once a temperature of 24°C is reached.

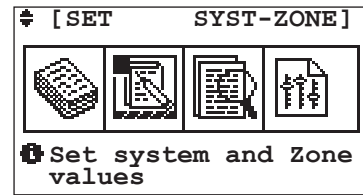

Table of movements		
Button	Screenshot	
Esc	0	MAIN
↑	2.1	SYSTEM/ZONE STATUS
←	2.2.1	SET VALUES
↓	2.3	SYSTEM/ZONE READOUTS

2.2.1 SET VALUES SCREENSHOT

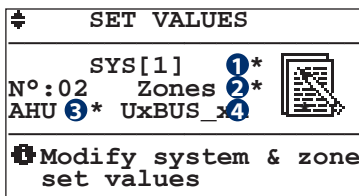
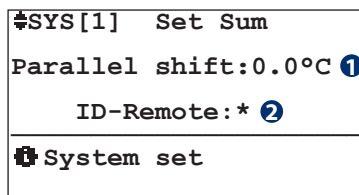

Table of variables	
No.	Description
1	When it flashes you can access the "Parallel shifting" screenshot
2	When it flashes you can access the "Zone Set Values" screenshot
3	When it flashes you can access the "AHU Set Values" screenshot
4	When it flashes you can access the "UxBUS_xx" screenshot

Table of movements		
Button	Screenshot	
Esc	2.2	SYSTEM/ZONE SET
← ←	2.2.1.1	PARALLEL SHIFTING
← ↓ ←	2.2.1.2	ZONE SET VALUES
← ↓ ↓ ←	2.2.1.3	DEHUMIDIFIERS
← ↓ ↓ ↓ ←	2.2.1.4	UxBUS_xx

This section allows modifying the operating parameters that characterise the system, zones and air handling units.

2.2.1.1 PARALLEL SHIFTING SCREENSHOT



By accessing the system setting subscreenshot, you can set the "Parallel shifting" parameter according to the season operating mode.

This parameter manages the shift that can be introduced in the system delivery temperature calculation obtained through the compensation line.

Table of variables	
No.	Description
1	When it flashes you can modify the value
2	When it flashes you can access the "Type of Signal" screenshot

Table of movements		
Button	Screenshot	
Esc	2.2.1	SET VALUES
← ← ←	2.2.1.1.1	DIGITAL INPUTS

2.2.1.1.1 DIGITAL INPUT SCREENSHOT

Type of signal	Wi-M1 digital input
	N/N
	0/0
1 ID1: Season	-NO
2 ID2: General On-Off	-NO
3 B7: -----	-NO
4 B8: -----	-NO

You can define the meaning of each of the 4 digital inputs on the WI-M1 board. The admitted values are:

- -----
- **Chiller Alarm**
- **Boiler Alarm**
- **Remote thermostat for low temp. Sys.1**
- **Remote thermostat for low temp. Sys.2**
- **Remote thermostat for high temp.**
- **General On-Off**
- **Season**
- **boost UCxx1**
- **boost UCxx2**
- **Economy/Comfort**

A value is allocated according to the chosen meaning
NO (=normally open)
NC (=normally closed)

N.B. For the expansion WI-Sx it is possible to configure only the inputs for low- and high-temperature call.

Table of variables	
No.	Description
1	Digital Input 1 Setting
2	Digital Input 2 Setting
3	Digital Input 3 Setting
4	Digital Input 4 Setting

Table of movements	
Button	Screenshot
	2.2.1.1 PARALLEL SHIFTING

2.2.1.2 ZONE SET VALUES SCREENSHOT

ZONE 1 Set Sum Val	
25.0%	55%
Settings 24h Manual setpoints	

Table of variables	
No.	Description
1	Temperature value
2	Humidity value (or Index Comfort)

Table of movements		
Button	Screenshot	
	2.2.1	SET VALUES

By accessing the "Set Values Sum. (Summer)/Win (Winter)" submenu, you can establish the Temperature/Humidity comfort values for the various zones. These values come into play when the zone activation status is "Man" (see 2.1.1.1 - "Zone Status"). The zone and dehumidifier activation behaviour, together with the activation differentials and setpoints, are schematically summarised in figures 2.2.1, 2.2.2, 2.2.3 in the following page, where the temperature and humidity values of the relative season are considered. As for the sets, the system "On" and "Off" statuses are indicated.

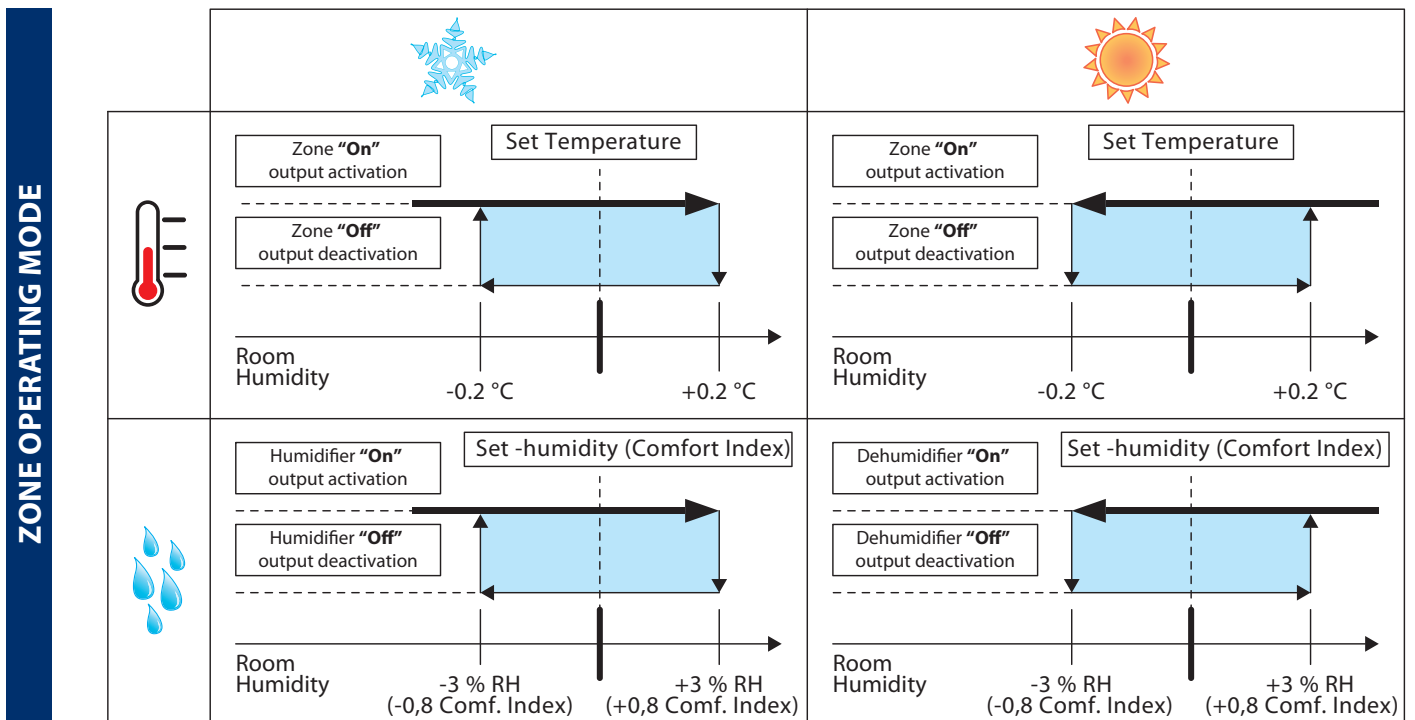

2.2.1.2 AHU SET VALUES SCREENSHOT

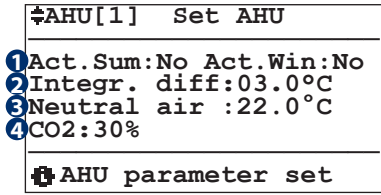

Table of variables	
No.	Description
1	Summer/Winter Integration Activation
2	Differential for the integration activation
3	Reference temperature for neutral air
4	CO2 value according to which AHU keeps air renewal on (only with QA sensor)

Table of movements		
Button	Screenshot	
	2.2.1	SET VALUES

2.2.1.4 UxBUS_xx SCREENSHOT

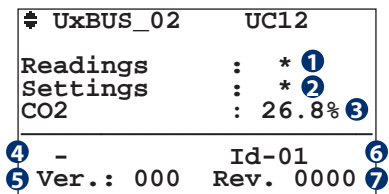

Table of variables	
No.	Description
1	Enter the readings menu
2	Enter the settings menu
3	View CO2 value (with QA probe present)
4	Referred to the Ux unit connected
5	Referred to the software version installed in the unit.
6	Referred to the number of the selected unit.
7	Referred to the software revision installed in the unit.

Table of movements		
Button	Screenshot	
	2.2.1	READOUTS
	2.3.1.4.1	UxBUS_xx READOUTS
	2.3.1.4.2	UxBUS_xx SETTINGS

2.2.1.4.2 UxBUS_xx SET VALUES SCREENSHOT

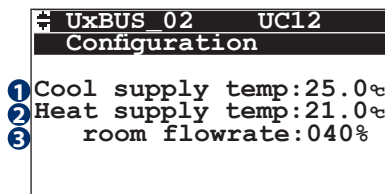

Table of variables	
No.	Description
1	Summer supply temperature setting
2	Winter supply temperature setting
3	Room flow rate

Table of movements		
Button	Screenshot	
	2.2.1.4	UxBUS_xx

2.3 SYSTEM/ZONE READOUT SCREENSHOT

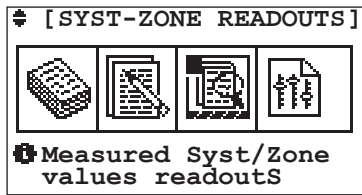
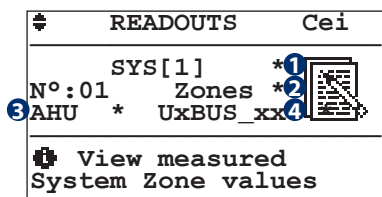

Table of movements		
Button	Screenshot	
Esc	0	MAIN
↑	2.2	SYSTEM/ZONE SET
←	2.3.1	READOUTS
↓	2.4	PROGRAMMING

Menu 2.3 "System/Zone Readouts" allows reading all the operating values detected by the various systems and zones correlated to them.

2.3.1 READOUT SCREENSHOT



The Readout section allows displaying the essential SYSTEM and ZONE operating data.

Table of variables	
No.	Description
1	When it flashes you can access the "System Readouts" screenshot
2	When it flashes you can access the "Zone Readouts" screenshot
3	When it flashes you can access the "AHU Readouts" screenshot
4	When it flashes you can access the "UxBUS_xx Readouts" screenshot

Table of movements		
Button	Screenshot	
Esc	2.3	SYSTEM/ZONE READOUTS
← ←	2.3.1.1	SYSTEM READOUTS
← ↓ ←	2.3.1.2	ZONE READOUTS
← ↓ ↓ ←	2.3.1.3	AHU READOUTS
← ↓ ↓ ↓ ←	2.3.1.4	UxBUS_xx READOUTS

2.3.1.1 SYSTEM READOUT SCREENSHOT

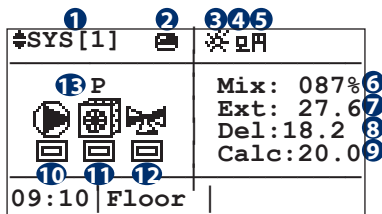

Table of movements		
Button	Screenshot	
←	2.3.1.2	ZONE READOUT
Esc	2.3.1	READOUTS

Table of variables	
No.	Description
1	Name of the system
2	System Activation Status ☐ = Activated ☐ = Deactivated
3	Season ❄ = Summer ❄ = Winter
4	Low Temperature production external request from a remote contact
5	High Temperature production external request from a remote contact
6	Mixing valve opening percentage
7	External temperature

No.	Description
8	Detected delivery temperature
9	Detected calculated delivery temperature
10	System pump activation status ☐ = Activated ☐ = Deactivated
11	Production activation status ☐ = Activated ☐ = Deactivated Production Type ❄ = Cooling 🔥 = Heating
12	Mixing valve activation status ☐ = Activated ☐ = Deactivated
13	It appears only in winter season P = Hot water produced through Heat Pump C = Hot water produced through Boiler

2.3.1.2 ZONE READOUT SCREENSHOT

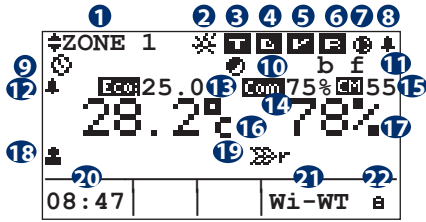

Table of movements		
Button	Screenshot	
	2.3.1	READOUTS

Table of variables	
No.	Description
1	Name of the zone
2	Season ☀ = Summer ❄ = Winter
3	Off / On Status of the digital output (potential free contact) available on the electronic board associated to the Zone. Related to the Zone energy supply according to the temperature setpoint. If the zone is in programming mode, the "Comfort" or "Economy" status is displayed with the programming set corresponding to the operating time.
4 (A)	The zone dehumidification Off / On Status (available only when the Zone is configured with a TA/H sensor and a Dehumidifier). If the zone is in programming mode, the "Comfort" or "Economy" status is displayed with the programming set corresponding to the operating time.
4 (B)	The zone humidification Off / On Status (available only when the Zone is configured with a TA/H sensor and a humidifier). If the zone is in programming mode, the "Comfort" or "Economy" status is displayed with the programming set corresponding to the operating time.
5	The zone ventilation Off / On Status (available only when the Zone is configured with a TA/H sensor and a Dehumidifier with ventilation).
6	The zone Air Renewal Off / On Status (available only when the Zone is configured with a TA/H sensor and a Dehumidifier with Air Renewal).

No.	Description
7	Dehumidification Pump in operation
8	Zone alarm active
9	Zone status = Off = On = Programming = Manual programming
10	Integration in operation
11	b = Boost in operating f = Free-Cooling in operation
12	Zone alarm active through external digital contact
13	Displays the Comfort/Economy status + desired Temperature
14	Displays the Comfort/Economy status + desired Humidity
15	Displays the Comfort Index
16	Measured temperature
17	Measured humidity (only for TA/H "temperature/humidity" sensors).
18	Zone Temperature/ Humidity activation through external digital contact
19	Indicates that the zone is replicated
20	Time
21	Type of terminal
22	Setpoint modification from terminal block

In this screenshot it is also possible to change the functioning status of the selected zone.

The "On" status of the system allows the zones to operate according to the set operating status.

The OFF status of the zones involves its deactivation: this status automatically switches off the zone, regardless of the set status of the selected zone.

The MAN status enables zone operation according to the measured Temperature/Humidity and set setpoint (menu 2.2 "System / Zone Set").

The PGM status enables zone operation according to the timeslots and the Temperature/Humidity programming settings (menu 2.4 "Programming").

The status PGM activates the zone relating to the timeslots (menu 2.4 "Programming") and the manual settings for Temperature/Humidity (menu 2.2 "Set Impianto/Zone").

2.3.1.3 AHU READOUT SCREENSHOT

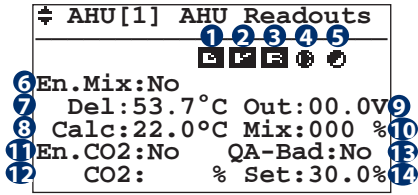

Table of movements		
Button	Screenshot	
	2.3.1	READOUTS

No.	Description
6	Mixing calibration enabled
7	Value detected by the duct sensor
8	Calculated mixing temperature
9	Mixing valve output value
10	Mixing valve opening percentage
11	Presence of the air quality sensor
12	CO2 percentage value detected by the duct sensor
13	Too much CO2 in the air
14	Threshold for the quality of clean air

Table of variables		
No.	Description	
1 (A)	AHU dehumidification Off / On status	
1 (B)	AHU humidification Off / On status	
2	AHU ventilation Off / On status	
3	AHU air renewal Off / On status	
4	AHU pump activated	
5	Integration request activated	

2.3.1.4 UxBUS_xx SCREENSHOT

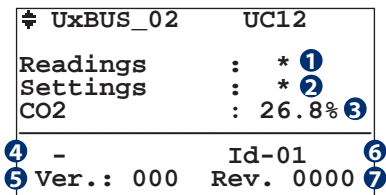

Table of movements		
Button	Screenshot	
	2.3.1	READOUTS
	2.3.1.4.1	TEMPERATURE READINGS FOR UxBUS_xx

No.	Description
4	Referred to the Ux unit connected
5	Referred to the software version installed in the unit.
6	Referred to the number of the selected unit.
7	Referred to the software revision installed in the unit.

Table of variables		
No.	Description	
1	Enter the readings menu	
2	Enter the settings menu	
3	View CO2 value (with QA probe present)	

2.3.1.4.1 UxBUS_xx TEMPERATURES READOUTS SCREENSHOT

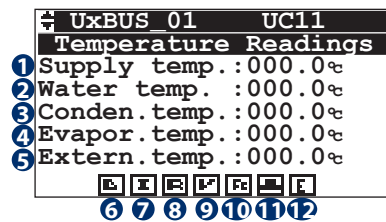

Table of movements		
Button	Screenshot	
	2.3.1.4	UxBUS_xx
	2.3.1.4.1.4	GENERAL INFO READINGS
	2.3.1.4.1.2	FAN READINGS

No.	Description
8	Fresh air renewal status: = OFF = ON
9	Ventilation status: = OFF = ON
10	Free-cooling status: = OFF = ON
11	Boost status: = OFF = ON
12	Economy status: = OFF = ON

Table of variables		
No.	Description	
1	Delivery air temperature.	
2	Inflow water temperature .	
3	Condensation coil temperature.	
4	Evaporation coil temperature.	
5	External temperature detected.	
6	Dehumidifier status: = OFF = ON	
7	Integration status: = OFF = ON	

2.3.1.4.1.2 UxBUS_xx FAN READINGS SCREENSHOT

```

UxBUS_01 UC11
Fans Readings
1 rpm Room :00000
2 rpm Exhaust:00000
3 Press. Tran. A:0000.0
4 Press. Tran. B:0000.0
5 H2O Pos. Valve:00000
    
```

Table of movements		
Button	Screenshot	
Esc	2.3.1.4	UxBUS_xx
↑	2.3.1.4.1.1	TEMPERATURE READINGS
↓	2.3.1.4.1.3	DEFROST READINGS

Table of variables	
No.	Description
1	Speed for supply air fan
2	Speed for exhaust air fan
3	Transducer A differential air pressure reading
4	Transducer B differential air pressure reading
5	H2O Valve position.

2.3.1.4.1.3 DEFROST READINGS SCREENSHOT

```

UxBUS_01 UC11
Reading defrost
1 Defrost ON/Off: 000
2 Num. Defrost: 000
    
```

Table of movements		
Button	Screenshot	
Esc	2.3.1.4	UxBUS_xx
↑	2.3.1.4.1.2	FAN READINGS
↓	2.3.1.4.1.4	DA PARAMETERS READINGS

Table of variables	
No.	Description
1	It shows the defrosting status
2	It shows the number of defrosting cycles already performed

2.3.1.4.1.4 DA PARAMETERS READINGS SCREENSHOT

```

UxBUS_01 UC11
Parameters Readings
1 Superheat Temp: 00.0c
2 H2O P Pos.Valv.: 100%
3 H2O C Pos.Valv.: 100%
    
```

Table of movements		
Button	Screenshot	
Esc	2.3.1.4	UxBUS_xx
↑	2.3.1.4.1.3	DEFROST READINGS
↓	2.3.1.4.1.5	FREE COOLING READINGS

Table of variables	
No.	Description
1	Overheating temperature
2	Position of the water valve for the pre-treatment coil
3	Position of the water valve of the condensation coil

2.3.1.4.1.5 UxBUS_xx FREE COOLING READINGS SCREENSHOT

```

UxBUS_01 UC11
Unit Info
1 FreeCooling: Pre
    
```

Table of movements		
Button	Screenshot	
Esc	2.3.1.4	UxBUS_xx
↑	2.3.1.4.1.4	DA PARAMETERS READINGS
↓	2.3.1.4.1.6	GENERAL INFO READINGS

Table of variables	
No.	Description
1	Free Cooling connection type

2.3.1.4.1.6 UxBUS_xx GENERAL INFO READINGS SCREENSHOT

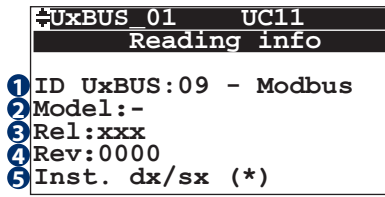

Table of movements		
Button	Screenshot	
Esc	2.3.1.4	UxBUS_xx
↑	2.3.1.4.1.5	LETTURE FREE COOLING
↓	2.3.1.4.1.7	LETTURE FILTRI

Table of variables	
No.	Description
1	Modbus net index.
2	Model
3	Software version installed
4	Software revision installed
5	* Right / left Installat. (WHR only)

2.3.1.4.1.7 UxBUS_xx FILTERS READINGS SCREENSHOT

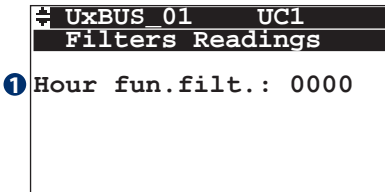

Table of movements		
Button	Screenshot	
Esc	2.3.1.4	UxBUS_xx

Table of variables	
No.	Description
1	Indicates the machine operating hours for the filters in use. (* Only for WHR units).

2.4 SYSTEM/ZONE PROGRAM SCREENSHOT

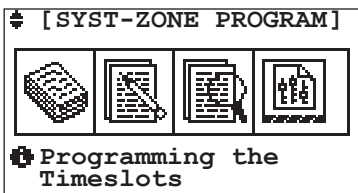

Table of movements		
Button	Screenshot	
Esc	0	MAIN
↑	2.3	SYSTEM/ZONE READOUTS
←	2.4.1	PROGRAMMING
↓	2	SYSTEM/ZONE MENU

Menu 2.4 "Programming" allows weekly setting the required temperature, humidity, ventilation and air renewal for every hour of the day.

NB: The "Ventilation" and "Air Renewal" functions (where provided) allow respectively for dehumidifier operation in "ventilation only" mode and forced indoor air renewal

with outdoor air.

The user must first set the programs (STD: standard, WD: weekday, WE: weekend, Pg1...Pg5: generic programs) to decide the desired temperature or humidity (ventilation/air renewal) around the clock.

For example, to manage the temperature, you can set the STD program as follows:

- 22°C from 06:00 to 12:00,
- 20°C from 13:00:00 to 18:00:00,
- 21°C from 18:00:00 to 22:30:00.

and to manage humidity, you can set program Pg1 as follows:

- 40% humidity from 08:00 to 12:00 (only in "SUMMER" mode),
- 30% humidity from 13:00 to 22:30 (only in "SUMMER" mode). and so on for all the available programs.

The temperature or humidity set by the user in the various timeslots are identified with the "COMFORT" status; on the other hand, whenever there is no temperature or humidity associated to the timeslot (in the example between 12:00 and 13:00 and between 22:30 and 6:00), the temperature or humidity will be identified with the "ECONOMY" status, also settable as you wish.

Upon setting the various programs, the user must decide the ones to assign to every day of the week.

For example:

from Monday to Friday you can apply the "STD" program for the temperature and "Pg1" for the humidity; Saturday "WD" for the temperature and "Pg1" for humidity; Sunday "WE" for humidity and "STD" for ventilation, etc.

2.4.1 PROGRAMMING SCREENSHOT

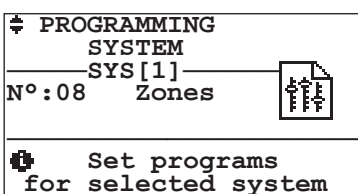

Table of movements		
Button	Screenshot	
Esc	2	SYSTEM/ZONE MENU
←	2.4.1.1	TEMPERATURE
↑ ↓		CAMBIO IMPIANTO

The programming menu dedicated to the zones that belong to the selected system **allows the user to activate some functions in the desired timeslots.**

In screenshot "2.4.1 Programming" you can select only the system to be programmed; the possible functions shall be analysed in detail at a later stage.

2.4.1.1	TEMPERATURE SCREENSHOT
2.4.1.2	DEHUMIDIFICATION SCREENSHOT HUMIDIFICATION SCREENSHOT
2.4.1.3	VENTILATION SCREENSHOT
2.4.1.4	AIR RENEWAL SCREENSHOT

2.4.1.5	SYSTEM ECONOMY SCREENSHOT
2.4.1.6	UxBUS_xx ECONOMY SCREENSHOT
2.4.1.7	AUX 1 SCREENSHOT
2.4.1.8	AUX 2 SCREENSHOT

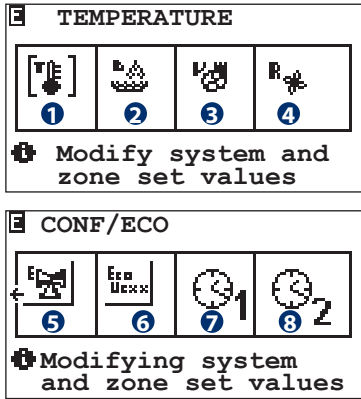

Table of movements		
Button	Screenshot	
Esc	2.4.1	PROGRAMMING
←	2.4.1.1	TEMPERATURE
	2.4.1.2	DEHUMIDIFICATION / HUMIDIFICATION
	2.4.1.3	VENTILATION
	2.4.1.4	AIR RENEWAL
	2.4.1.5	SYSTEM ECONOMY
	2.4.1.6	UxBUS_xx ECONOMY
	2.4.1.7	AUX 1
	2.4.1.8	AUX 2

This screenshot allows selecting the parameter to be programmed in the next screenshot.

The parameters that can be modified are the following:

- Room temperature
- Dehumidification / Humidification
- Ventilation
- Air renewal
- System Economy
- UxBUS_xx Economy
- AUX1 Economy
- AUX2 Economy

Table of variables		
No.	Description	
1	Temperature timeslot programming	
2	Dehumidification timeslot programming	
3	Ventilation timeslot programming	
4	Air Renewal timeslot programming	
5	System timeslot programming	
6	UxBUS_xx timeslot programming	
7	Auxiliary contact 1 timeslot programming	
8	Auxiliary contact 2 timeslot programming	

Example: To program weekly the temperature function, you can select icon 1) "Temperature" pressing "ARROW UP" and "ARROW DOWN" until the cursor flashes on the first symbol on the left.

Press "ENTER" to access its programming (screenshot 2.4.1.1.1 Type of weekly program).

Warning! The "Dehumidification" icon is only visible during summer; during winter, you will be able to view the "Humidification" icon. The functions are visible only if enabled during configuration.

2.4.1.x.1 TYPE OF PROGRAM - WEEKLY SCREENSHOT

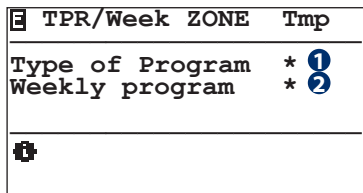

Table of movements		
Button	Screenshot	
Esc	2.4.1.1 2.4.1.2 2.4.1.3 2.4.1.4	TEMPERATURE DEHUMIDIFICATION / HUMIDIFICATION VENTILATION AIR RENEWAL
← ←	2.4.1.x(1).1.1	PROGRAMMING TYPE
← ↓ ←	2.4.1.x(1).1.2	WEEKLY ZONE PROGRAM

This screenshot allows customising the previously chosen parameter programming (TEMPERATURE / DEHUMIDIFICATION / HUMIDIFICATION / VENTILATION / AIR RENEWAL) for:

- Type of Program **Std / Fer / Fes / Pg1 / Pg2 / Pg3 / Pg4 / Pg5**
- ZONE weekly program: weekly association **MO / TU / WE / TH / FR / SA / SU** of the various zones and dehumidifiers to the generic programs (Std / Fer / Fes / Pg1 / Pg2 / Pg3 / Pg4 / Pg5).

Table of variables		
No.	Description	
1	Access to the Programming Type screenshot	
2	Access to the Zone weekly program screenshot	

2.4.1.x.1.1 TYPE OF PROGRAM SCREENSHOT

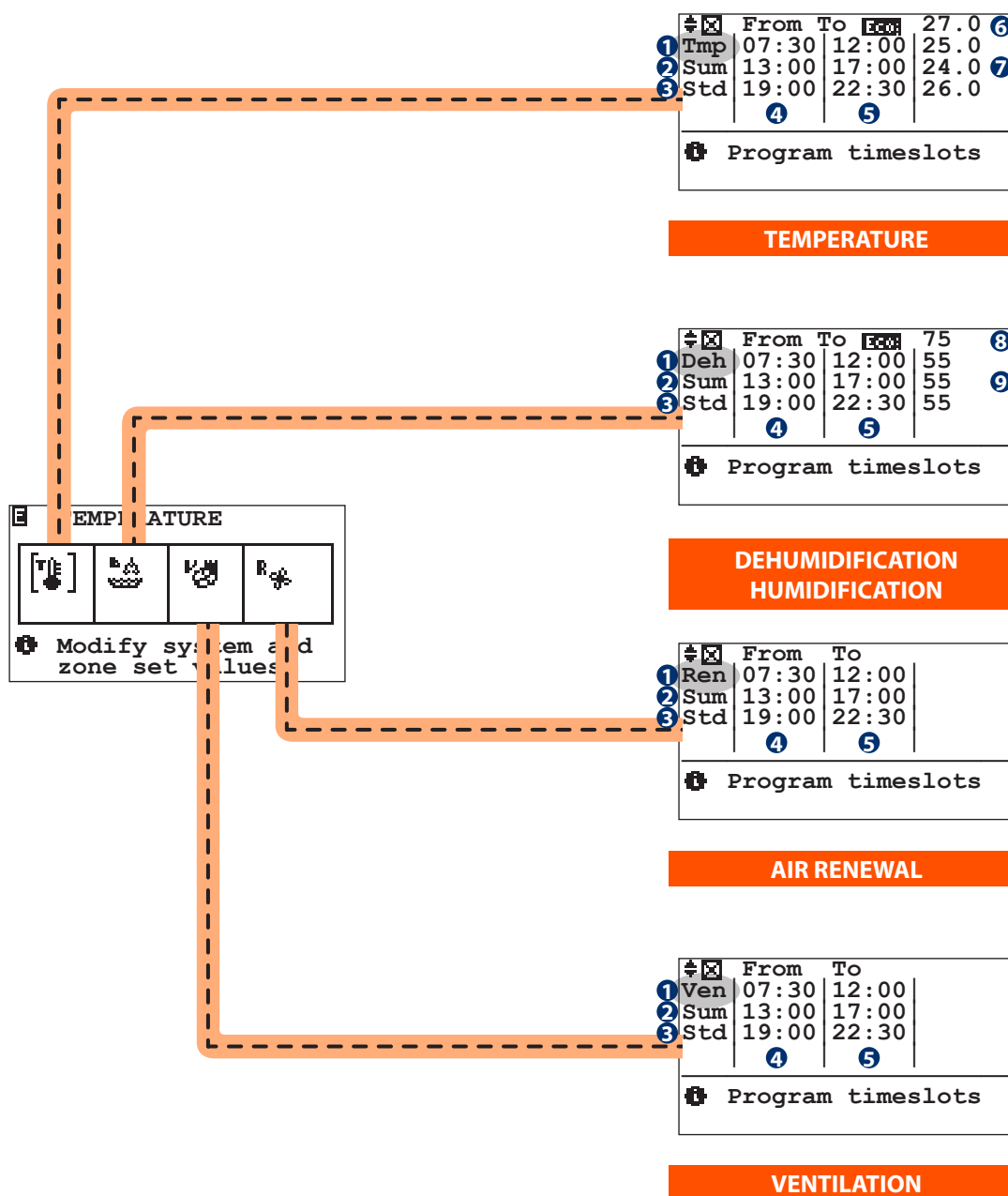

Table of movements		
Button	Screenshot	
	-	COPY
	2.4.1.x.1	TYPE OF PROGRAM/WEEKLY

Table of variables	
No.	Description
1	Functions to be programmed: Tmp = Temperature Deh = Dehumidification / Hum = Humidification Ven = Ventilation Ren = Air renewal
2	Season Sum = Summer Win = Winter

No.	Description
3	Program TYPE: Std = Standard Fer = Weekday Fes = Weekend Pg1...Pg5 = Program 1...5
4	Starting Time
5	End Time
6	"Economy" Temperature
7	"Comfort" temperature
8	"Economy" Humidity
9	"Comfort" Humidity

Once the functions to be programmed in the previous menu (e.g.: temperature) have been defined, you can customise the programs:

- **Std**: Standard Program
- **Fer**: Weekday
- **Fes**: Weekend
- **Pg1...Pg5**: Program 1..5.

The first thing to do is define the operating set outside of the "Economy Set" programming.

Programming allows dividing the day in 3 programming slots. For each of these slots, you must define the starting time. "From" and the ending time "To" with the respective "Comfort set" (i.e., the temperature to be maintained).

Dehumidification, ventilation and air renewal selected in the previous menu 2.4.1.1 "Temperature / Dehumidification / Ventilation / Air renewal" must be set the same way.

Warning!

Unlike for temperature and dehumidification/ Humidification, ventilation and renewal only require programming the function activation and switch-off slots. The weekly dehumidification program it is only available during the summer, whereas during winter only the Humidification program will be available. This must be set for all the TA/H zones. Reference to the dehumidifier is implicit in the TA/H sensor setting configured during the customisation phase.

Copy program

In the event of similar programs, you can copy them in order to easily modify the differences between them. Upon selecting the type of program (e.g.: Win Tmp Std), press PRG to access the copy program screenshot.

- There are two ways to copy a program:
- **Total**: The program (e.g.: Win Tmp Std - screenshot "A") will be copied to all the programs "Std / Fer / Fes / Pg1 / Pg2 / Pg3 / Pg4 / Pg5".
 - **Single**: The program (e.g.: Win Tmp Std) will be copied only to the selected program (e.g.: Win Tmp Std - to Pg1).

"Std" program to be copied

```

From To 27.0
Tmp 07:30 12:00 25.0
Win 13:00 17:00 24.0
Std 19:00 22:30 26.0

Program timeslots
    
```

Prg

```

Std COPY >>>
Tmp
Total
Single Pg1
    
```

Prg

"Std" program copied to all programs ("Fer", "Fes", "Pg1", etc.)

```

Std COPY >>>
Tmp
Total
Single Pg1
    
```

↑ ↓

WD
WE
Pg1

Prg

"Std" program copied to the selected program

Program setting example

From	To	Temp	18.0
00:00	00:00	00.0	
Imp	00:00	00:00	00.0
Win	00:00	00:00	00.0
Std	00:00	00:00	00.0

Program timeslots

"Economy" setting

From	To	Temp	18.0
00:00	00:00	00.0	
Imp	00:00	00:00	00.0
Win	00:00	00:00	00.0
Std	00:00	00:00	00.0

Program timeslots

....
19°C
20°C
21°C
....

1st TIMESLOT

From	To	Temp	18.0
06:00	00:00	00.0	
Imp	00:00	00:00	00.0
Win	00:00	00:00	00.0
Std	00:00	00:00	00.0

Program timeslots

Modify values

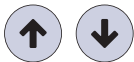

00:00
.....
23:45

From	To	Temp	18.0
06:00	12:00	22.0	
Imp	00:00	00:00	00.0
Win	00:00	00:00	00.0
Std	00:00	00:00	00.0

Program timeslots

Modify values

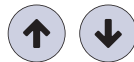

00:00
.....
23:45

From	To	Temp	18.0
06:00	12:00	22.0	
Imp	00:00	00:00	00.0
Win	00:00	00:00	00.0
Std	00:00	00:00	00.0

Program timeslots

Modify values



.....
19
20
21
.....

2nd TIMESLOT

From	To	Temp	18.0
06:00	12:00	22.0	
Imp	13:00	00:00	00.0
Win	00:00	00:00	00.0
Std	00:00	00:00	00.0

Program timeslots

Modify values



00:00
.....
23:45

From	To	Temp	18.0
06:00	12:00	22.0	
Imp	13:00	18:00	00.0
Win	00:00	00:00	00.0
Std	00:00	00:00	00.0

Program timeslots

Modify values



00:00
.....
23:45

From	To	Temp	18.0
06:00	12:00	22.0	
Imp	13:00	18:00	20.0
Win	00:00	00:00	00.0
Std	00:00	00:00	00.0

Program timeslots

Modify values



.....
19
20
21
.....

3rd TIMESLOT

From	To	Temp	18.0
06:00	12:00	22.0	
Imp	13:00	18:00	20.0
Win	19:00	00:00	00.0
Std	00:00	00:00	00.0

Program timeslots

Modify values



00:00
.....
23:45

From	To	Temp	18.0
06:00	12:00	22.0	
Imp	13:00	18:00	20.0
Win	19:00	22:30	00.0
Std	00:00	00:00	00.0

Program timeslots

Modify values



00:00
.....
23:45

From	To	Temp	18.0
06:00	12:00	22.0	
Imp	13:00	18:00	20.0
Win	19:00	22:30	21.0
Std	00:00	00:00	00.0

Program timeslots

Modify values



.....
19
20
21
.....

Setting a program with temperature timeslots.

Dehumidification, ventilation and air renewal selected in the previous menu 2.4.1.1 "Temperature / Dehumidification / Ventilation / Air renewal" must be set the same way.

Unlike for temperature and dehumidification/humidification, ventilation and renewal only require programming the function activation and switch-off slots.

2.4.1.x.1.2 WEEKLY SCREENSHOT

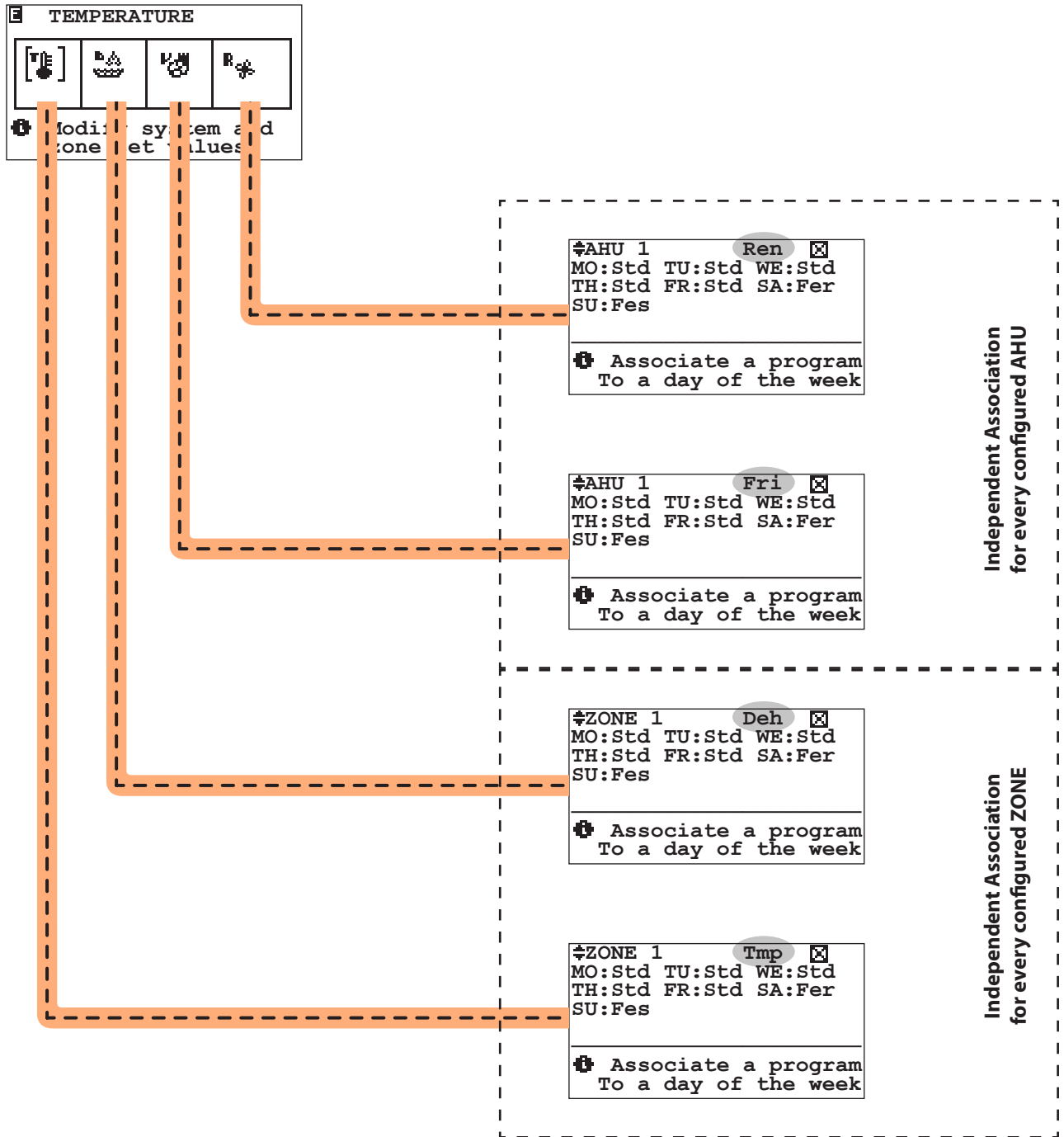

Once the programs have been set (refer to menu 2.4.1.1.1.1 "Type of program"), you can associate the days of the week: MO / TU / WE / TH / FR / SA / SU
 other types of program:
 Std / Fer / Fes / Pg1 / Pg2 / Pg3 / Pg4 / Pg5 / Off / Man.

Table of movements		
Button	Screenshot	
Esc	2.4.1.x.1	TYPE OF PROGRAM/WEEKLY

Example of weekly assignment

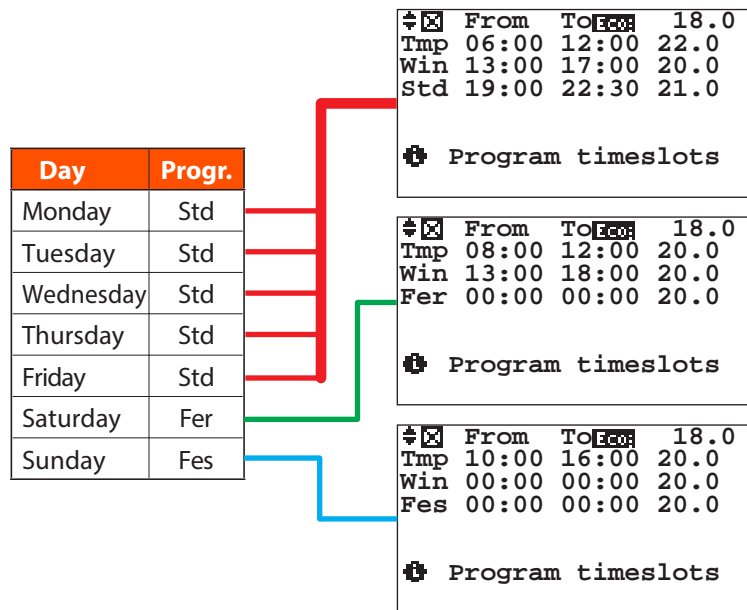

Copy of a weekly program

In the event the control unit manages more than one zone, you can copy the program set for one zone to another. Below you can find an example of how to copy a temperature program from ZONE1 to ZONE2.

Example: Upon selecting the zone to which you want to copy the program, press PRG to proceed. This procedure can be used for all the ZONES configured in the system.

"ZONE 1" weekly program to be copied

```

#ZONE 1      Tmp  ☒
MO:Std TU:Std WE:Std
TH:Std FR:Std SA:Fer
SU:Fes

☒ Associate a program
To a day of the week
    
```



```

ZONE 1 COPY >>>
  Tmp
  *02:ZONE 2  ☒
  Single
    
```

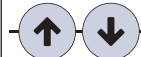

Zone 2
 Zone 3
 Zone 4



ZONE 1 weekly program copied to the selected zone

2.4.1.x TYPE OF PROGRAM SCREENSHOT

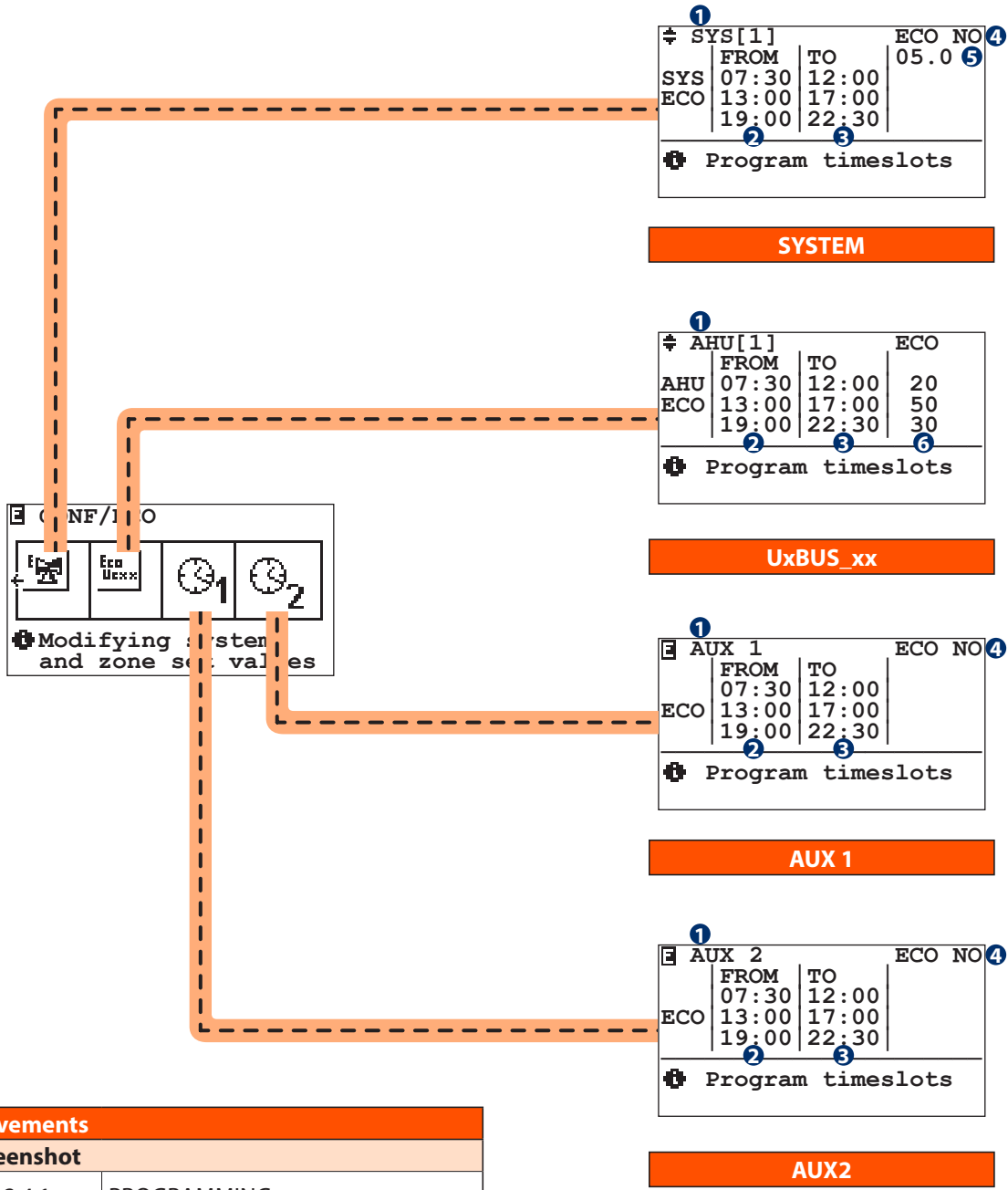
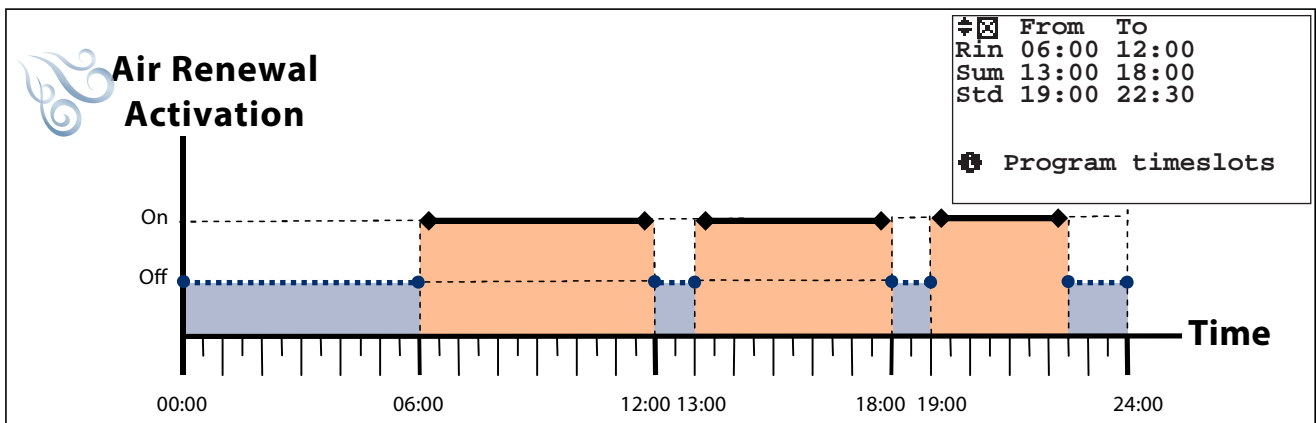
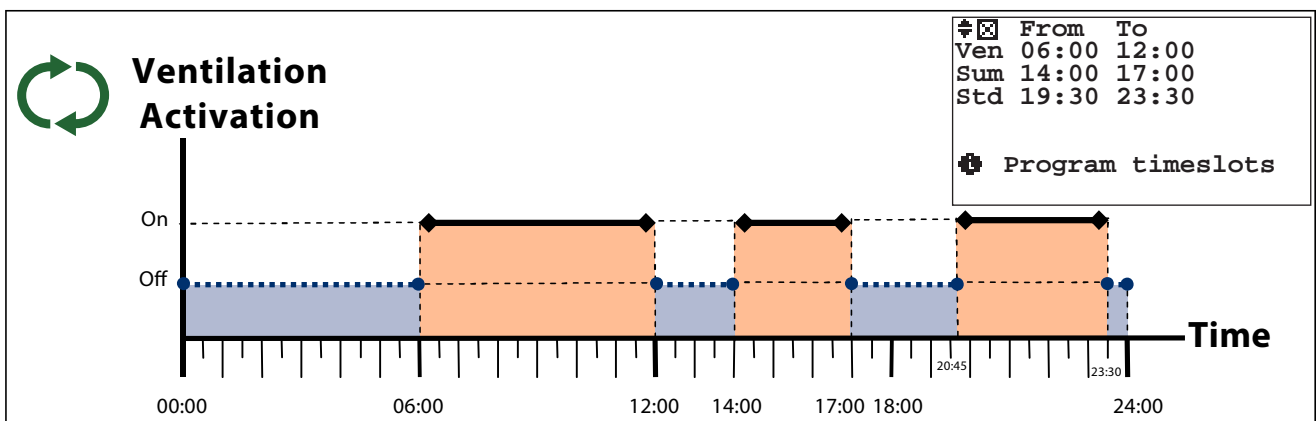
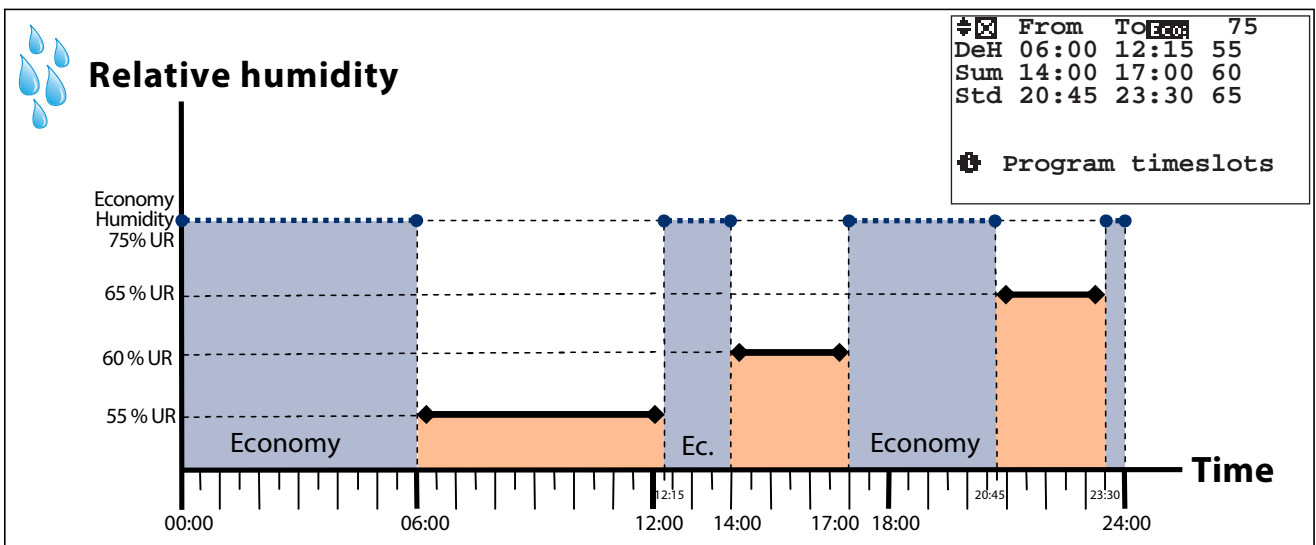
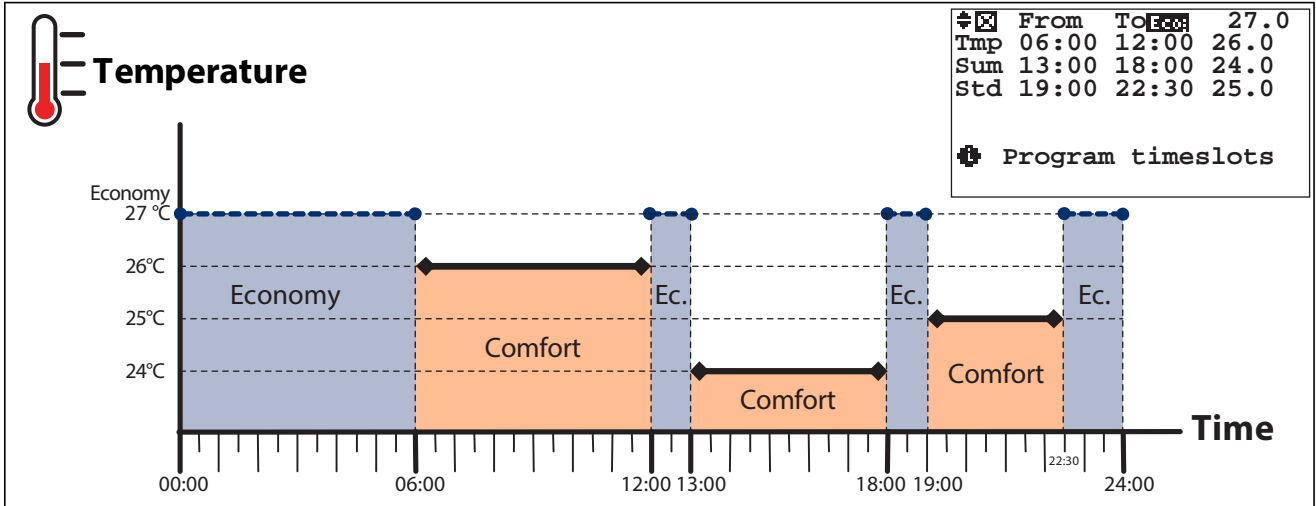

Table of movements	
Button	Screenshot
Esc	2.4.1 PROGRAMMING

Table of variables	
No.	Description
1	Programmable operations: Sys = System (different for each system) Ahu = UCxx (different for each unit) Aux1 = Auxiliary contact 1 (NO5) Aux2 = Auxiliary contact 2 (NO6)
2	Start time

No.	Description
3	Finish time
4	Enable/Disable function programming
5	Adjustable delta on system calculated temperature
6	Flow rate adjustment percentage for UCxx

Example of weekly assignment



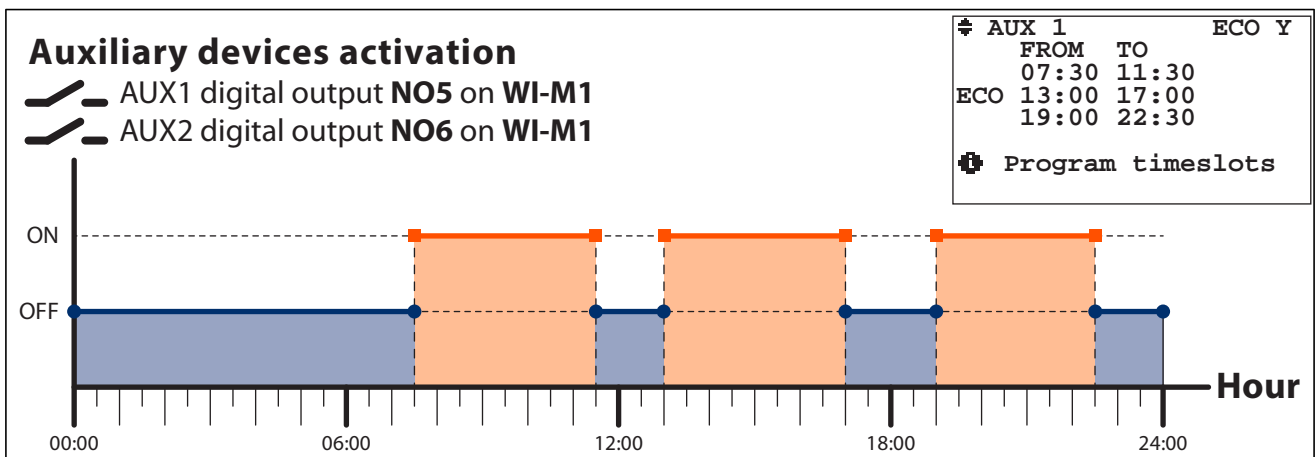
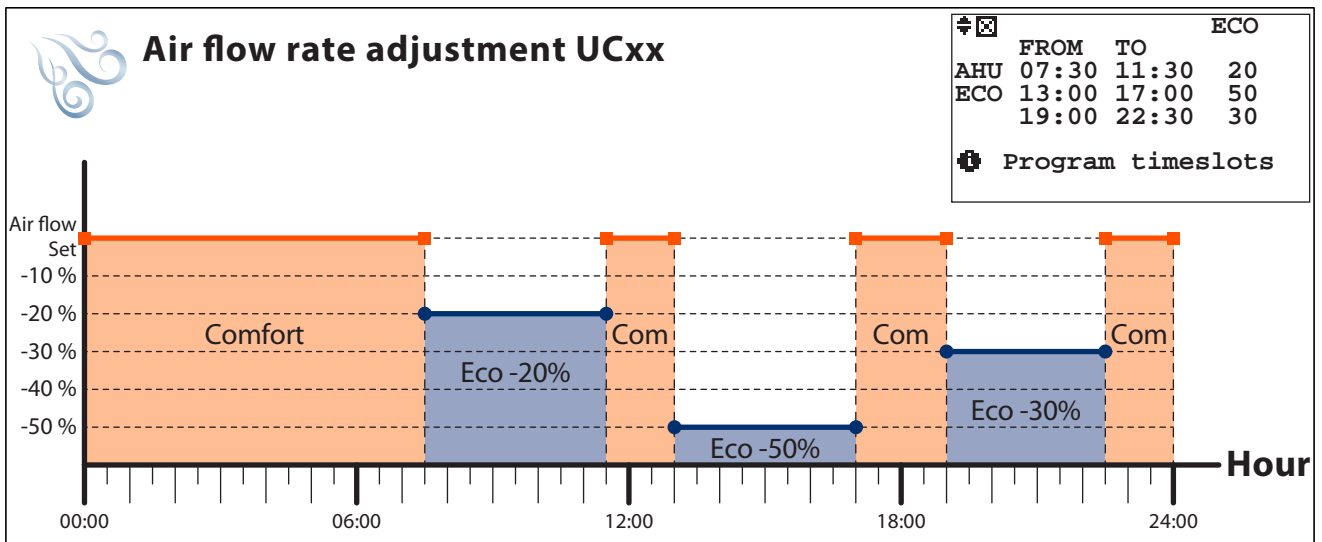
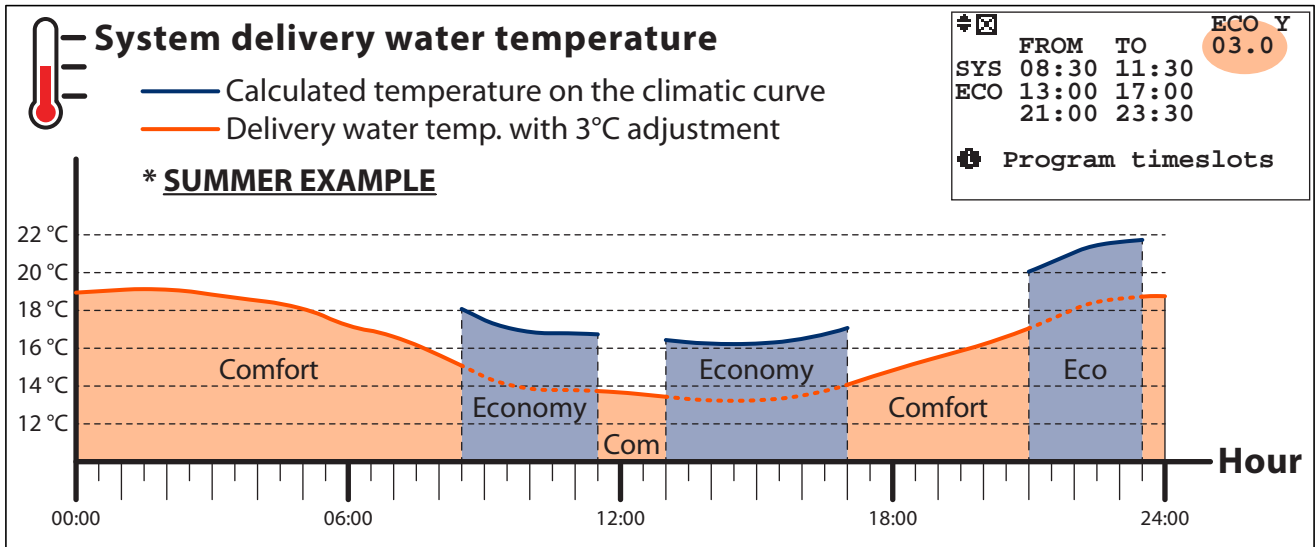

Example of manual operation (summer)

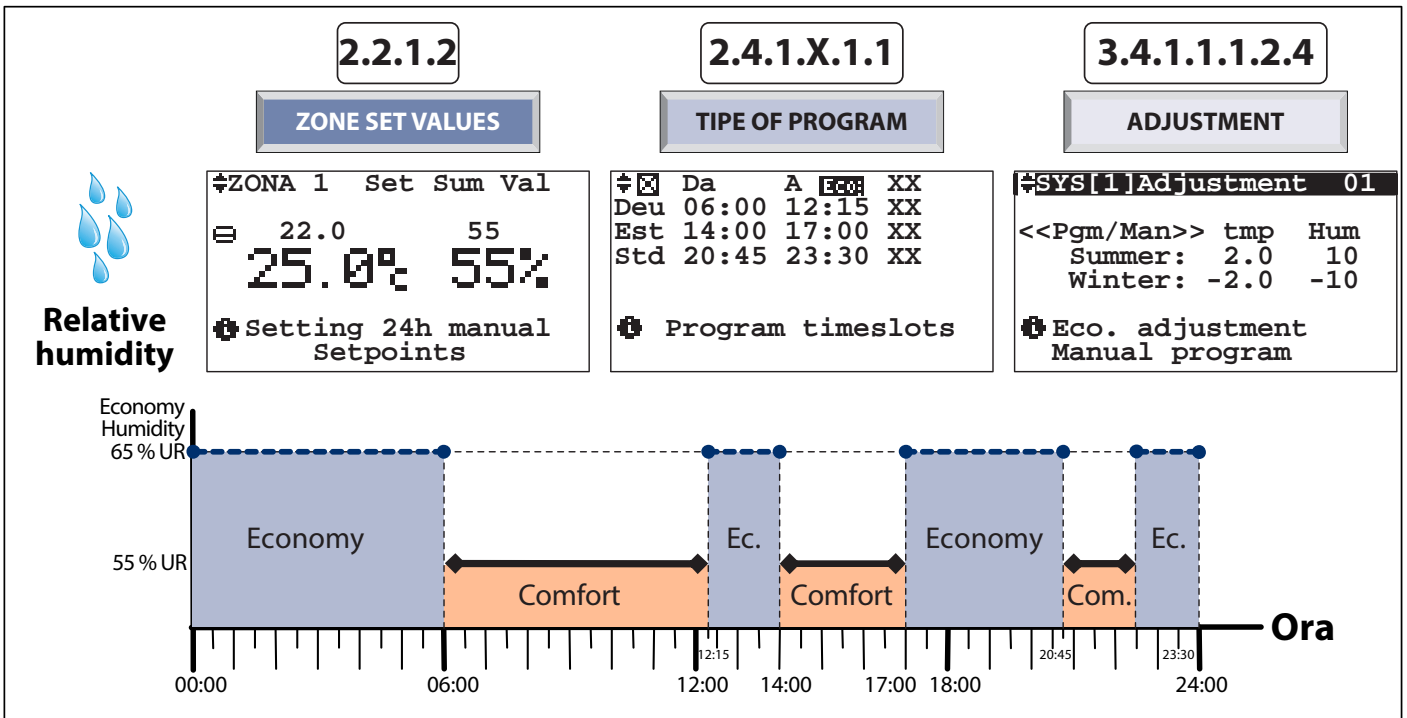
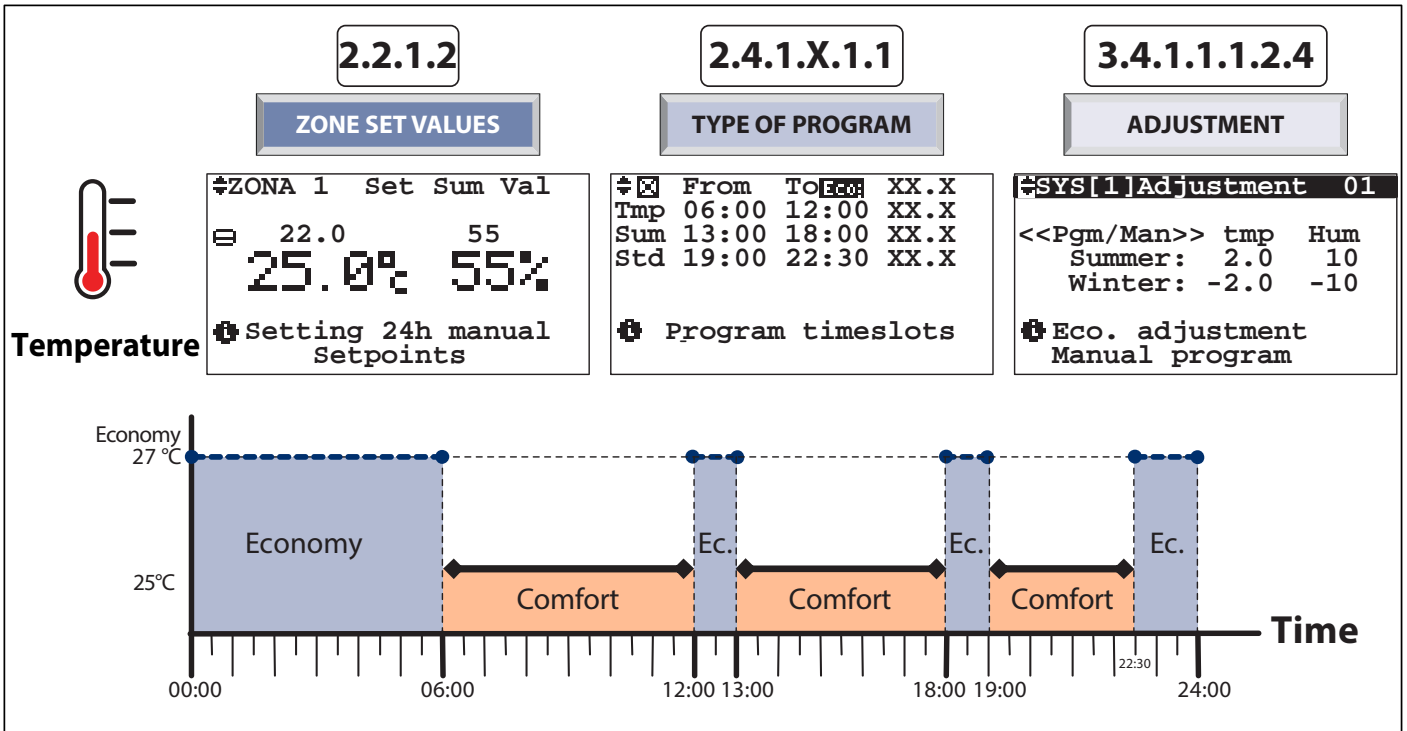

Example of weekly assignment

In the kitchen (zone 1) with the following Comfort set:

From MONDAY to FRIDAY:

22°C temperature between 06:00 and 12:00
 20°C temperature between 13:00 and 18:00
 20°C temperature between 19:00 and 22:30
 55% humidity: between 06:00 and 12:15
 60% humidity: between 14:00 and 17:00
 65% humidity: between 20:45 and 23:30

SATURDAY:

20°C temperature between 08:00 and 12:00
 20°C temperature between 13:00 and 18:00
 55% humidity: between 00:00 and 24:00

SUNDAY:

20°C temperature between 10:00 and 16:00
 55% humidity: between 00:00 and 24:00

GUIDED PROCEDURE:

- If necessary, set the "Summer" mode -> refer to menu 3.1 "Set season"; this allows also setting the dehumidification function (this function is NOT available during the "Winter" season).
- If you haven't done it previously, you can assign a different name to "Zone 1" to simplify its identification (e.g. you can call it "kitchen well") -> refer to menu 3.4.1.1.2 "Zone Menu - zone names".
- 1) Access menu 2.4.1.1 "Temperature / Dehumidification / Ventilation / Air renewal";
 2) Select the **"Temperature"** section -> menu 2.4.1.1.1 "Type of weekly program - TPR/Week ZONE" will appear;
 3) Select **"Type of program"**;
 4) Set the required temperature timeslots in the available programs ("Std", "WD", etc.) (for example set **"STD"** with the temperature timeslots that you wish from Monday to Friday; **"WD"** program for Saturday etc. (for the settings follow the indications provided in menu 2.4.1.1.1.1 "Programming").
- 1) Return to menu 2.4.1.1 "Temperature / Dehumidification / Ventilation / Air renewal";
 2) Select the **"dehumidification"** section -> menu 2.4.1.1.1 "Type of weekly program - TPR/Week ZONE" will appear;
 3) Select **"Type of program"**;
 4) Set the required humidity percentage in the various timeslots of the available programs ("Std", "WD", etc.).
- If necessary, set the timeslots for the "air renewal" and "ventilation" functions - where available.
- 1) Access menu 2.4.1.1.1 "Type of weekly program - TPR/Week ZONE";
 2) Select **"Zone weekly program"**;
 3) Associate the various programs for managing temperature and humidity (and if necessary ventilation and air renewal) to every day of the week. for example MON-FRI = "Std" for temperature and "Pg1" for humidity, SAT= "WD" for temperature and humidity, SUN= "WE" For temperature and "Pg2" for humidity).

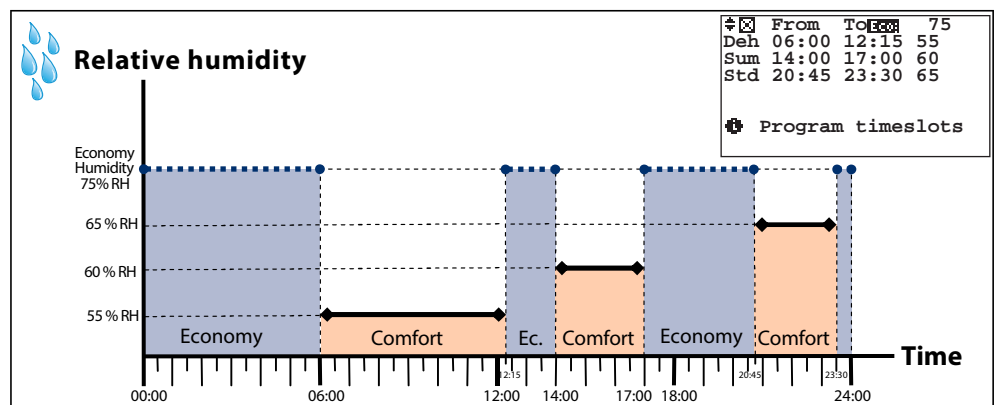
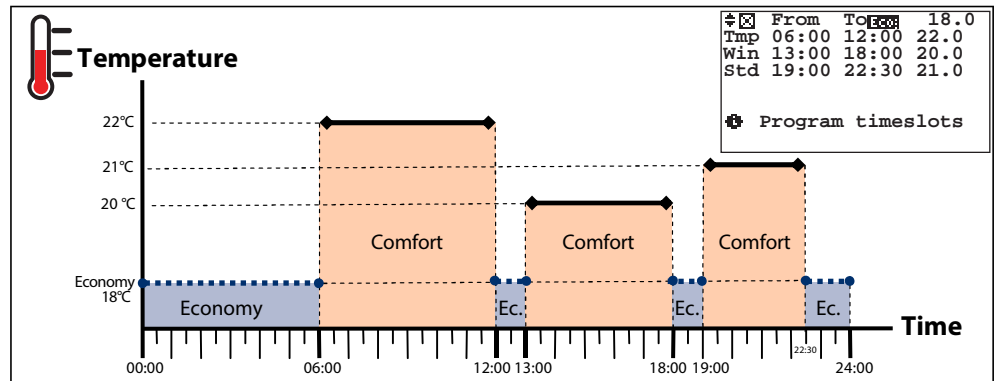
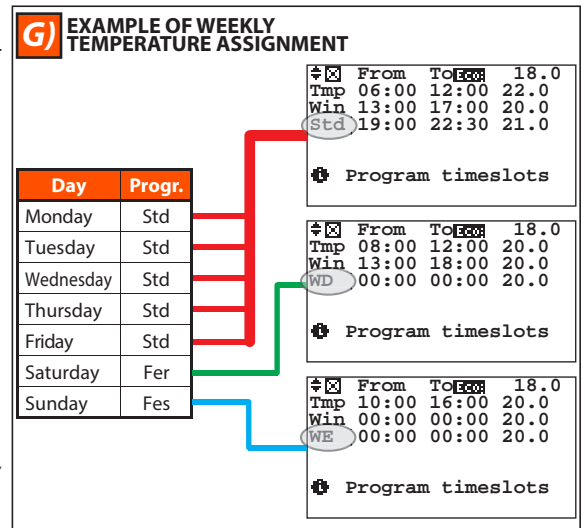
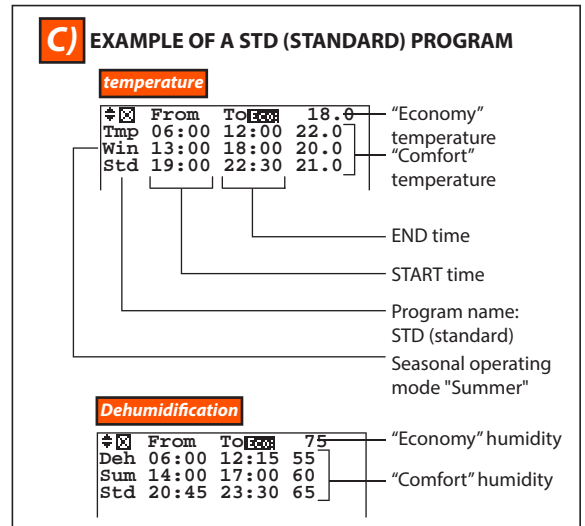

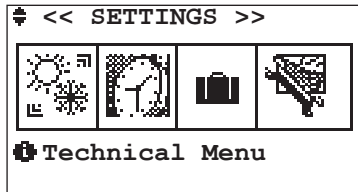

Table of movements		
Button	Screenshot	
Esc	0	MAIN
↑	2	SYSTEM/ZONE MENU
←	3.1	SET SEASON
↓	0	MAIN

Through menu 3 "Settings menu" you can:

menu 3.1 = Change season (SUMMER or WINTER)

menu 3.2 = Change/set the date and time

menu 3.3 = Set a time range within which the system shall remain off (for examples during holidays)

menu 3.4 = Change the system name (e.g., System 1 becomes: floor1), and zones (e.g.: Zone 1 becomes: Kitchen), and dehumidifiers or modify the system settings

ADDRESS 3 SETTINGS MENU /

3.1

SET SEASON SCREENSHOT

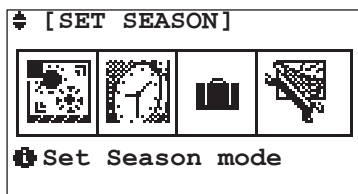

Table of movements		
Button	Screenshot	
Esc	0	MAIN
↑	3	SETTINGS MENU
←	3.1.1	SEASON
↓	3.2	SET DATE-TIME

ADDRESS 3 SETTINGS MENU / 3.1 SET SEASON /

3.1.1

SEASON SCREENSHOT

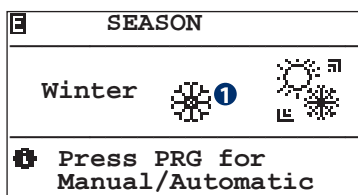



Table of movements		
Button	Screenshot	
Esc	3.1	SET SEASON
Prg	3.1.1.1	AUTOMATIC SEASON

Table of variables	
No.	Description
1	Set season:  = Summer  = Winter

In the SEASON section you can set the seasonal operating mode of the control unit. This setting is allowed only if the control unit is set to Winter/Summer operating mode and the digital input for the season is not configured (see screenshot 2.2.1.1.1).

This setting is not allowed if the control unit is configured in SLAVE mode (in a centralised system).

3.1.1.1 Automatic/Manual Season

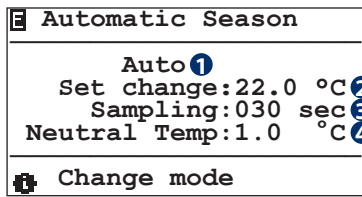

Table of movements		
Button	Screenshot	
Esc	3.1.1	SEASON

Table of variables	
No.	Description
1	Set Auto/Manual Season
2	External temperature value that determines the change of season
3	Time elapsed between detections
4	Differential beyond which a zone can request the change of season regardless of the external temperature.

The Man/Auto Freehold allows changing the season as follows:
Man: the change of season is managed by the user through the Summer/Winter field

Auto: The change of season is managed by the control unit, according to set temperature. The control unit will decide whether to set the season to Summer or Winter and, according to the external temperature, whether the system must work in heating or in cooling mode.

2, 3, 4 variables are irrelevant if the change of season is set to MANUAL.

WARNING: This function is activated only for systems that can be hydraulically set to the automatic heating/cooling mode.

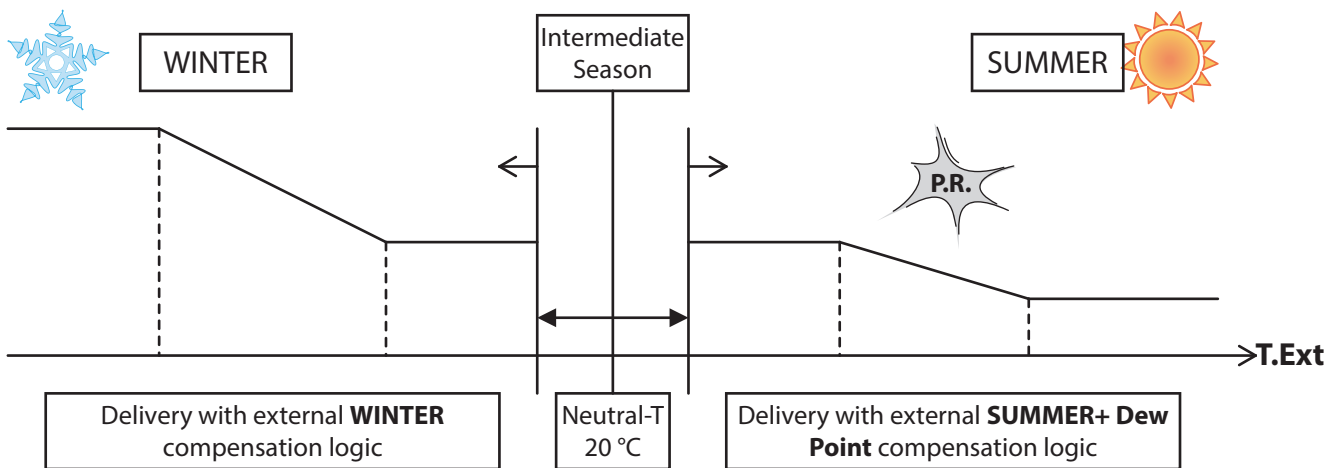

3.2 SET DATE-TIME SCREENSHOT

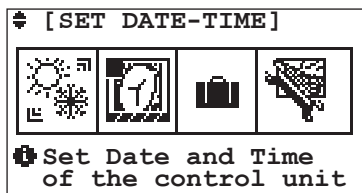
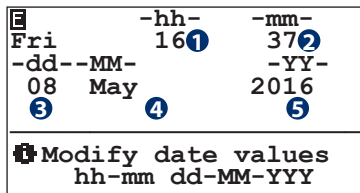

Table of movements		
Button	Screenshot	
Esc	0	MAIN
↑	3.1	SET SEASON
←	3.2.1	DATE / TIME
↓	3.3	SET HOLIDAYS

3.2.1 SET DATE-TIME SCREENSHOT



The "DATE/TIME" screenshot allows changing the date and time configured in the control unit.

N.B. This setting is not allowed if the control unit is configured in SLAVE mode (in a centralised system).

Table of movements		
Button	Screenshot	
Esc	3.2	SET DATE/TIME

Table of variables	
No.	Description
1	Hour value
2	Minute value
3	Day value
4	Month value
5	Year value

3.3 SET HOLIDAYS SCREENSHOT

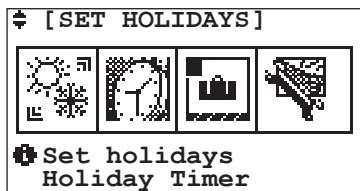

Table of movements		
Button	Screenshot	
Esc	0	MAIN
Up Arrow	3.2	SET DATE/TIME
Left Arrow	3.3.1	HOLIDAYS
Down Arrow	3.4	TECHNICAL MENU

3.3.1 SET HOLIDAYS SCREENSHOT

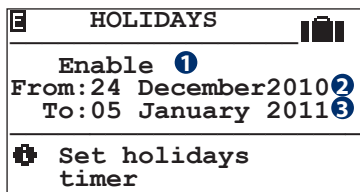

Table of movements		
Button	Screenshot	
Esc	3.3	SET HOLIDAYS

Table of variables	
No.	Description
1	Holiday Settings Status Enabled/Disabled
2	Holidays starting date
3	Holidays ending date

The "HOLIDAYS (Timer/Holidays)" section allows setting a time range within which the system remains off. The Holidays Timer can be **Enabled** or **Disabled**: When enabled, the control unit remains off in the time range between the two dates entered.

The time range provides for the following parameters:

- **FROM:** Date of the 1st day of absence dd-MM-YY (Day-Month-Year).
- **TO:** Date of the last day of absence dd-MM-YY (Day-Month-Year).

3.4 TECHNICAL MENU SCREENSHOT

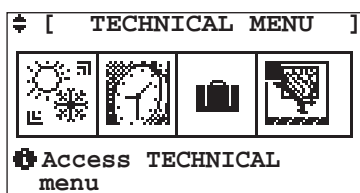

Table of movements		
Button	Screenshot	
Esc	0	MAIN
Up Arrow	3.3	SET HOLIDAYS
Left Arrow	3.4.1	PASSWORD
Down Arrow	3.4	SETTINGS MENU

3.4.1 *PASSWORD SCREENSHOT*

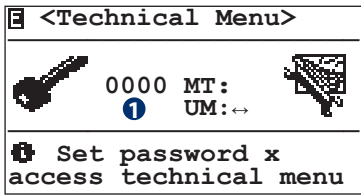

Table of movements		
Button	Screenshot	
Esc	3.4	TECHNICAL MENU

Table of variables	
No.	Description
1	Numerical field from entering the password

By entering the correct password **[0123]** in the "TECHNICAL MENU" screenshot, you can access the menu that allows changing sensitive user details pertaining to the control unit settings, which are listed below.

3.4.1.1 *MAIN SCREENSHOT*

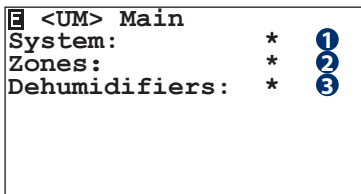

Table of movements		
Button	Screenshot	
Esc	3.4	TECHNICAL MENU

Table of variables	
No.	Description
1	Access to system settings
2	Access to the area for modifying zone names
3	Access to the area for modifying dehumidifier names

3.4.1.1.1 *SYSTEM SCREENSHOT*

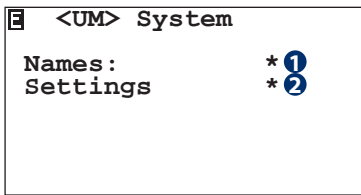

Table of movements		
Button	Screenshot	
Esc	3.4.1.1	MAIN

Table of variables	
No.	Description
1	Access to the area for modifying system names
2	Access to system settings

This section allows modifying the system name or the operating parameters.

3.4.1.1.1.1 *SYSTEM NAME SCREENSHOT*

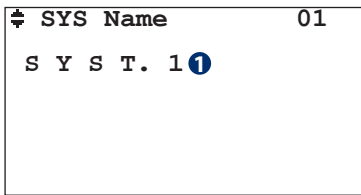

Table of movements		
Button	Screenshot	
Esc	3.4.1.1.1	SYSTEM

Table of variables	
No.	Description
1	Alphanumerical fields of the system names

This section allows modifying the name (max 6 characters) of the system.

3.4.1.1.2 SETTINGS SCREENSHOT

SYS[1]	01
Settings	
Definition of parameters for mixing	

Table of movements		
Button	Screenshot	
	3.4.1.1.1	SYSTEM

In the event of multisystems, you must select the system on which to modify the parameters.

The 3.4.1.1.2 "Settings" section allows accessing and modifying the parameters that affect system operation. This is why these parameters must not be modified by unqualified personnel.

The Manufacturer cannot be held liable for system malfunctions caused by improper configuration of these parameters.

3.4.1.1.1.1 CLIMATE SCREENSHOT

SYS[1]	Climate	01
1 Type: External/Room 2 Season: Win + Sum:		
Climate and season		

Table of movements		
Button	Screenshot	
	3.4.1.1.1.2.7	SUPPLY LIMIT TEMPERATURE
	3.4.1.1.1.2	SETTINGS
	3.4.1.1.1.2.2	WINTER COMPENSATION

Table of variables	
No.	Description
1	Type of system climate control
2	System seasonal operating mode

Climate with external sensor

Only the external sensor is installed in this type of configuration.

Delivery temperatures calculated according to the external compensation curve. The system activates the boiler/chiller and the pump, adjusting the mixing valve to the required calculated temperature. Partial disconnection of the system is controlled by external controls by means of remote thermostats.

Season:

- **Winter:** Temperature control is activated only during the winter season.
- **Winter + Summer** Temperature control is activated during Winter + Summer.
- **Summer:** Temperature control is activated only during the summer season. Summer configuration requires extra caution on system external humidity control.

Climate with External + Room sensor

This type of configuration requires the installation of an external sensor and of at least one HT/H or HT room sensor.

Season:

- **Winter:** Temperature control is activated only during the winter season. The control unit will deactivate all the summer functions, dehumidifier control, etc. Compensation occurs considering the external temperature curve and (optional) room dynamic compensation.
- **Winter + Summer** Temperature control is activated inner Winter + Summer. Compensation occurs considering the seasonal external temperature curve and (optional) room dynamic compensation. During summer, in cooling mode, the logic will consider the limitation set by the room dew point.
- **Summer:** Temperature control is activated only during the summer season. The control unit will deactivate all the winter functions. Compensation occurs considering the external temperature curve and (optional) room dynamic compensation. The logic will consider the limitation set by the room dew point.

3.4.1.1.1.2.2 WINTER COMPENSATION SCREENSHOT

#SYS [1]	WinComp	01
Min	Max	Off
TExt: -05.0	20.0	0.0
TDel: 45.0	22.0	
 Winter Compensation Curve		

Table of movements		
Button	Screenshot	
↑	3.4.1.1.1.2.1	CLIMATE
Esc	3.4.1.1.1.2	SETTINGS
↓	3.4.1.1.1.2.3	SUMMER COMPENSATION

The parameters to be entered in the screenshot represent the characterisation of the compensation curve shown in the figure below. The control unit, will adjust the water delivery temperature according to the outdoor temperature.

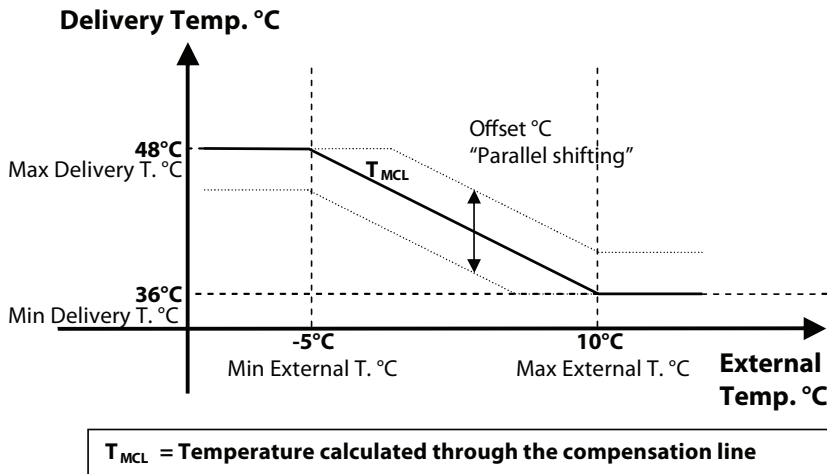

Winter Compensation Line Reference Settings

WALL/CEILING				
Name	Min	Max	Name	Val
TExt	-5°C	10°C	Off.	0
Del.T	48°C	36°C		

FLOOR				
Name	Min	Max	Name	Val
TExt	-5°C	20°C	Off.	0
Del.T	45°C	22°C		

3.4.1.1.1.2.3 SUMMER COMPENSATION SCREENSHOT

#SYS [1]	SumComp	01
Min	Max	Off
TExt: 23.0	32.0	0.0
TDel: 20.0	15.0	
 Summer Compensation Curve		

Table of movements		
Button	Screenshot	
↑	3.4.1.1.1.2.2	WINTER COMPENSATION
Esc	3.4.1.1.1.2	SETTINGS
↓	3.4.1.1.1.2.4	ADJUSTMENT

The parameters to be entered in the screenshot represent the characterisation of the compensation curve shown in the figure below. The control unit will adjust the water delivery temperature according to the outdoor temperature and to the dew point.

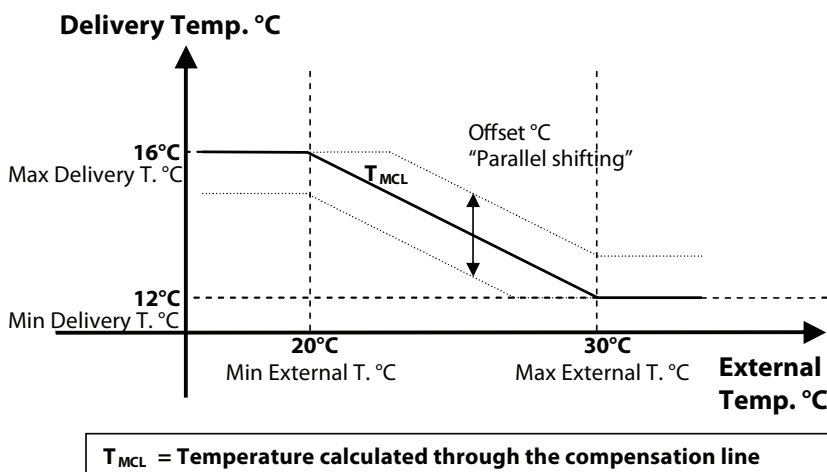

Summer Compensation Line Reference Settings

WALL/CEILING				
Name	Min	Max	Name	Val
TExt	20°C	30°C	Off.	0
Del.T	16°C	12°C		

FLOOR				
Name	Min	Max	Name	Val
TExt	23°C	32°C	Off.	0
Del.T	20°C	15°C		

3.4.1.1.1.2.4 ADJUSTMENT SCREENSHOT

SYS [1] Adjustment 01	
<<Pgm/Man>>	tmp Hum
Summer:	2.0 ① 10 ②
Winter:	-2.0 ③ -10 ④
Eco. adjustment Manual program	

The parameters to be entered in the screenshot represent the adjustment to be added to the set values for temperature and humidity, in the economy section of the manual programming.

Table of movements		
Button	Screenshot	
↑	3.4.1.1.1.2.3	SUMMER COMPENSATION
Esc	3.4.1.1.1.2	SETTINGS
↓	3.4.1.1.1.2.5	TYPE OF STRUCTURE

Table of variables	
No.	Description
①	Differential for temperature setting in summer
②	Differential for humidity setting in summer
③	Differential for temperature setting in winter
④	Differential for humidity setting in winter

3.4.1.1.1.2.5 TYPE OF STRUCTURE SCREENSHOT

SYS [1] DELTA STR. 01	
Delta Structure:	2.0
Type of screed	

Table of movements		
Button	Screenshot	
↑	3.4.1.1.1.2.4	ADJUSTMENT
Esc	3.4.1.1.1.2	SETTINGS
↓	3.4.1.1.1.2.5	DYNAMIC COMPENSATION

This screenshot allows entering a parameter that characterises the type of screed (wood, plasterboard, etc.). This parameter affects the system delivery temperature, which is calculated according to the thermal resistance of the structure used. Below are some indicative parameters according to the system structure:

Thickness	Floor		B!Klimax/Ceiling/Wall
	Delta - Structure with tile	Delta - Structure with wood	Delta structure
Between 3 and 3.5 cm	2	3	2
Between 4 and 4.5 cm	3	4	
Between 5 and 6 cm 4 5	4	5	
Between 7 and 8 cm	5	6	

3.4.1.1.1.2.6 DYNAMIC COMPENSATION SCREENSHOT

*SYS[1] DynComp 01	
1 Enable:Yes Pilot:01	2
3 KDSum:3 KDWin:03	4
5 TMin:10.0 TMax:50.0	6
Room dynamic compensation	

Table of variables	
No.	Description
1	Enable Dynamic Compensation
2	Pilot Zone Value
3	Summer compensation value
4	Winter compensation value
5	Minimum summer temperature
6	Maximum winter temperature

Table of movements		
Button	Screenshot	
↑	3.4.1.1.1.2.5	TYPE OF STRUCTURE
Esc	3.4.1.1.1.2	SETTINGS
↓	3.4.1.1.1.2.7	SUPPLY TEMPERATURE LIMIT

In this section you can enable the dynamic compensation to calculate the delivery temperature by means of the **Enable** variable. Enabling the dynamic compensation provides for the allocation of a **pilot zone**, which affects the delivery temperature value obtained through the compensation line.

To identify this "Pilot Zone", the identification number of the zone, i.e., its position in the room sensor presence/type configuration. The value obtained from the difference between the required set and the measured temperature multiplied by the seasonal coefficient **KDEst/KDInv**, is added to the value of the temperature calculated through the compensation line (see cooling/heating curve T_{MCL}).

The value obtained will be valid if it falls within the "comfort" limit (limits due to the type of structure during winter and the dew point during summer) and the limits **TMin** for the summer value and **TMax** for the winter value.

Should the result not be valid, the calculated value will be the one set by the "comfort" limits (see delivery temperature calculation logic).

3.4.1.1.1.2.7 SUPPLY TEMPERATURE LIMIT SCREENSHOT

* Supply temp. limits	
SUMMER	WINTER
TMin:10.0	TMax:50.0
Room dynamic compensation	

Table of movements		
Button	Screenshot	
↑	3.4.1.1.1.2.6	DYNAMIC COMPENSATION
Esc	3.4.1.1.1.2	SETTINGS
↓	3.4.1.1.1.2.1	CLIMATE

Table of variables	
No.	Description
1	Minimum limit water temperature for mixed system for summer season
2	Maximum limit water temperature for mixed system for winter season

3.4.1.1.2 ZONE SCREENSHOT

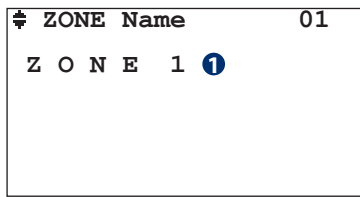

Table of movements	
Button	Screenshot
Esc	3.4.1.1 MAIN

Table of variables	
No.	Description
①	Alphanumerical fields of the zone names

This section allows modifying the name (max 6 characters) of the zone.

3.4.1.1.3 AHU SCREENSHOT

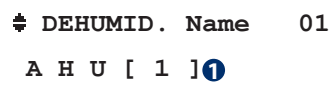

Table of movements	
Button	Screenshot
Esc	3.4.1.1 MAIN

Table of variables	
No.	Description
①	Alphanumerical fields of the AHU names

This section allows modifying the name (max 6 characters) of the AHU.



TROUBLESHOOTING

The red backlight on the "Alarm" button indicates that the control unit has detected a system failure or malfunction. To display them, press the "Alarm" button: once pressed, the screenshot will display all the information regarding the error. In the event of several errors, you can scroll through them using the **UP-DOWN** buttons. To return to the control unit menu press the "Alarm" button once again.

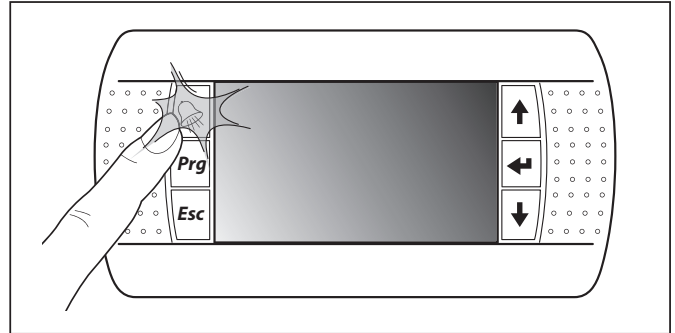

NB: When the problem is solved, the error will no longer be displayed when you access the alarm screenshot again. If everything in the control unit is working properly and you press the "Alarm" button, the screenshot indicating that there is no ongoing alarm shall appear.

Below are described the possible screenshot explaining each error.

Table D - Alarms





1) BOILER/HEAT PUMP ALARM

 <p style="text-align: center;">BOILER ALARM Or HEAT PUMP</p>	<p>Boiler/Heat Pump lock (Winter season). All the systems are disabled.</p>
--	---

2) CHILLER/HEAT PUMP ALARM:

 <p style="text-align: center;">CHILLER ALARM Or HEAT PUMP</p>	<p>Chiller/Heat Pump lock (Summer season). All the systems are disabled.</p>
---	--

3) ROOM SENSOR ALARM:

 <p style="text-align: center;">ZONE ALARM ROOM PROBE</p> <p style="text-align: center;">Enter to view</p>	 <p style="text-align: center;">ZONE 1</p> <hr/> <p>Off Line: Yes Temp. :  Humidity: - Deh: -</p>	<p>The presence of an error is indicated with , while its absence with -. When the sensor is communicating, errors in detecting Temp. (Temperature)/Humidity may occur. The Deh (Dehumidifier) session indicates the presence of an alarm concerning the dehumidifier serving the zone. NB: All the functions corresponding to the type of error are deactivated.</p>
---	---	---

4) SYSTEM ALARM — ROOM TEMPERATURE SENSOR/S:

<p>Temperature Sensor/s Faulty-Disconnected</p> <p style="text-align: center;">Enter Display ALARM</p>	<p style="text-align: center;">NO ROOM TMP</p> <hr/> <p style="text-align: center;">SYSTEM: SYST[1]</p>	<p>This error occurs during winter when there is no temperature detection in the system, i.e., all the temperature sensors connected to the system are malfunctioning or disconnected. NB: system Syst[1] is deactivated.</p>
--	---	--

5) SYSTEM ALARM — ROOM TEMPERATURE/HUMIDITY SENSOR/S:

<p>Temperature Sensor/s Faulty-Disconnected</p> <p style="text-align: center;">Enter Display ALARM</p>	<p style="text-align: center;">DEW POINT</p> <hr/> <p style="text-align: center;">SYSTEM: SYST[1]</p>	<p>This error occurs during summer when there is no temperature/humidity detection in the system, i.e., all the temperature/humidity sensors connected to the system are malfunctioning or disconnected. NB: system Syst[1] is deactivated.</p>
--	---	--

6) SYSTEM ALARM — EXTERNAL SENSOR:

EXTERNAL TEMPERATURE

This error occurs when the control unit does not detect the external temperature signal. NB: all the systems continue to operate, considering, during winter mode, the external temperature value set to +5°C and the maximum set to +30°C

7) SYSTEM ALARM — DELIVERY SENSOR:

ALARM DELIVERY SENSOR
Enter Display

DELIVERY TEMPERATURE
SYSTEM:SYST[1]

This error occurs when the control unit does not detect the delivery temperature signal. NB: system **Syst[1]** is deactivated

8) ROOM ANTIFREEZE:

ROOM ANTIFREEZE
Enter Display

ANTIFREEZE
SYSTEM:SYST[1]

This error occurs when, during winter, the temperature of a zone drops below 5°C (settable). All the zones are activated. The alarm is reset when the temperature in all the zones exceeds 6°C (settable)

9) THERMAL ALARM:

ALARM THERMAL
Enter Display

THERMAL
SYSTEM:SYST[1]

This occurs when, during winter, the delivery sensor detects a temperature of 45°C (settable) for a certain amount of time while the system is off

10) WI-Z UNIT ALARM:

OFF-LINE Wi-Z
Enter Display

Exp OffLine Wi- 1
Wi-Z11:‡ Wi-Z12:‡
Wi-Z13:‡ Wi-Z14:‡
Wi-Z15:‡ Wi-Z16:‡
Wi-Z17:‡ Wi-Z18:‡

In the event of failed communication, a bell will appear next to the expansion

11) WI-U UNIT ALARM:

OFF-LINE Wi-U
Wi-U11:‡ Wi-U12:‡
Wi-U21:- Wi-U22:-
Wi-U31:- Wi-U32:-
Wi-U41:- Wi-U42:-

In the event of failed communication, a bell will appear next to the expansion

12) MAIN UNIT ALARM:

OFF-LINE Main unit
Wi-M1: -Yes Wi-S2: ‡Yes
Wi-M1: ‡Yes Wi-S2: ‡Yes

In the event of failed communication, a bell will appear next to the control unit (provided that it is configured)
‡YES = Main unit OFFLINE
-YES = Main unit ONLINE
-NO = Main unit not configured

13) MASTER UNIT ALARM:

MASTER OFFLINE

This alarm occurs only in the WI.NET control units in the event there is no communication with the WI.MASTER.NET board

14) UxBUS UNIT ALARM:

OFF-LINE UxBUS-xx	
UC-11:-No	UC-31:-No
UC-12:-No	UC-32:-No
UC-21:-No	UC-41:Yes
UC-22:-No	UC-42:-No

In the event of failed communication, a bell will appear next to the UxBUS-xx unit (provided that it is configured)
 *YES = UxBUS OFFLINE
 -YES = UxBUS ONLINE
 -NO = UxBUS not configured

15) MANUAL INTEGRATION RESET:

Manual Reset:No Integration			
U-1	U-2	U-3	U-4
Yes	No	No	No
U-5	U-6	U-7	U-8
No	No	No	No

In the event of a Ventilation/Air Renewal block in one of the AHUs, it allows resetting the integration function without waiting for restoring the conditions

16) UC ALARM:

Errors/Faults
UxBUS

Enter Display

Alarms UC- 0 Gas low pressure:- Gas high press. :- Compr.high temp. :- Bus communicat. :- Pres. * next Alm	<p>Gas low pressure: Low pressure alarm on the refrigerating circuit (Unit of coolant discharge).(*) (*)Gas Missing in case of UAP 200 Gas high press.: High pressure alarm on the refrigerating circuit. Compr. high temp: High temperature alarm on compressor. Bus communicat.: BUS communication alarm.</p>
Alarms UC- 0 Defrosting: - High Temp.water: - Fan 1: - Fan 2: - Pres. * next Alm	<p>Defrosting: Ice presence alarm. High Temp. water: High temperature alarm on water.(*) (*)Water Low Temp in case of UAP 200 Fan 1: Fan input alarm. Fan 2: Fan expulsion alarm.</p>
Allarms UC- 0 Overload Evap.:b Pres. * next Alm	<p>Overload Evap.: It shows the alarm for the evaporator overload in DA units. (*) (*) on DA unit</p>
Allarms UC- 0 Gas Low Pressure.:b Pres. * next Alm	<p>Gas Low Pressure: It shows the gas low pressure due to lack of ventilation.(*) (*) on UAP 200 unit</p>
Alarms UC-i B Inlet Filter.:b Expulsion Filter.:b	<p>The dirty filters alarm is displayed when the set limit values are reached. (*) (*) CHR, WHR, UC xxx RDZ unit</p>
Res.All. UC-i B U-1 U-2 U-3 U-4 I I I I U-5 U-6 U-7 U-8 I I I I	<p>On this window you can reset the alarms of the DA units, by enabling the function on the top right. The input is sent by changing the value for each unit. (*) on DA, CHR, UC xxx RDZ unit</p>

17) ERRORS-FAILURES UxBUS:

<p>Block Alarm UxBUS</p> <p>Enter to view</p>	<p>🔍 Errors/Faults UC- 0</p> <p style="text-align: center;">Supply sensor:- Evaporation sensor:- Undercool. sensor:- Overheating sensor:-</p> <p style="text-align: center;">Pres. 📶 next Alm</p> <p style="text-align: center;">(CHR/WHR)</p>	<p>Supply sensor: Failure of the flow sensor (NTC1 sensor). Evaporation sensor: Failure of the evaporator sensor (NTC2 sensor). Undercool. sensor: Failure of the subcooling sensor C2 (NTC6 sensor). Overheating sensor: Failure of the overheating sensor (NTC4 sensor).</p>
	<p>🔍 Errors/Faults UC- 0</p> <p style="text-align: center;">Supply sensor:- Expulsion sensor:- Extraction sensor:- Overheating sensor:-</p> <p style="text-align: center;">Pres. 📶 next Alm</p>	<p>CHR Supply Sensor: Supply probe failure Expulsion Sensor: Expulsion probe failure Extraction Sensor: Extraction probe failure</p> <p>WHR NTC1: NTC1 sensor failure NTC4: NTC4 sensor failure NTC2: NTC2 sensor failure</p>
	<p>🔍 Errors/Faults UC-0</p> <p style="text-align: center;">Undercooling sens.:- Water temp. sensor:- Compr. temp. sensor :- Outdoor. temp. sens. :-</p> <p style="text-align: center;">Pres. 📶 next Alm</p> <p style="text-align: center;">(CHR/WHR)</p>	<p>Undercooling sens. Failure of the subcooling sensor C1 (NTC5 sensor). Water temp. sensor: Failure of the water temperature sensor (NTC7 sensor). Compr. temp. sensor: Failure of the compressor temperature sensor (NTC3 sensor). Outdoor. temp. sens.: Failure of the external temperature sensor (NTC8 sensor).</p>
	<p>🔍 Errors/Faults UC-0</p> <p style="text-align: center;">Undercooling sens.:- Water temp. sensor:- Compr. temp. sensor :- Outdoor. temp. sens. :-</p> <p style="text-align: center;">Pres. 📶 next Alm</p>	<p>CHR Outdoor. temp. sens.: Failure of the CHR external temperature sensor</p> <p>WHR NTC3: NTC3 sensor failure</p>
	<p>🔍 Errors/Faults UC-0</p> <p style="text-align: center;">Pressure transduc.:- Press. transduc.A:- Press. transduc.B:-</p> <p style="text-align: center;">Pres. 📶 next Alm</p> <p style="text-align: center;">WHR/ UC 500-MHE</p>	<p>Pressure transduc.: Failure of cooling transducer pressure.(*) (*) Capacitor probe (in case of UAP 200) Press. transduc.A: Failure of differential pressure sensor in the renewal area. Press. transduc.B: Failure of differential pressure sensor in the expulsion area.</p>
<p>🔍 Errors/Faults UC-0</p> <p style="text-align: center;">Pressure transduc.:- Fluximeter 1:- Fluximeter 2:- Fluximeter 3:-</p> <p style="text-align: center;">Pres. 📶 next Alm</p>	<p>WHR/ UC 500-MHE Fluximeter 1: Fluximeter 1 sensor failure Fluximeter 2: Fluximeter 2 sensor failure Fluximeter 3: Fluximeter 3 sensor failure (*) (*) Only for UC 500-MHE</p>	

18) FAILURE AQ SENSOR ALARM:

<p>QA out of order</p> <hr/> <p>QA-1:- QA-5:- QA-2:- QA-6:- QA-3:- QA-7:- QA-4:- QA-8:-</p>	<p>In this screen through the display of the alarm, you can see if the (configured) AQ sensor, not noticing a correct value, shows an error.</p> <p>📶 = Error - = Configured sensor is running or the sensor is not configured</p>
---	--







bit.ly/rdzwebsite

FAG0EA007BZ.02
07/2019



RDZ S.p.A.
📍 V.le Trento, 101 (S.S. 13 Km 64.5) 33077 SACILE (PN) - Italy
☎ Tel. +39 0434.787511 📠 Fax + 39 0434.787522
🌐 www.rdz.it ✉ rdzcentrale@rdz.it

**COMPANY WITH
QUALITY SYSTEM
CERTIFIED BY DNV GL
= ISO 9001 =**